

# Villa Door Station Quick Guide

A decorative graphic on the left side of the page consists of several overlapping curved lines in shades of gray. A small gray circle is positioned on the uppermost curve, and a small L-shaped corner bracket is located below it.

V1.00

# 1 Packing List

Contact your local dealer if the package is damaged or incomplete. The package contents may vary with device model and version.

No.	Name	Qty	Unit
1	Villa door station (hereinafter referred to "door station")	1	PCS
2	Wall mount bracket	1	PCS
3	Screwdriver	1	PCS
4	Screw components <sup>(1)</sup>	1	Set
5	Paper nameplate <sup>(2)</sup>	1	Set
6	Drill template	1	PCS
7	Product documents	1	Set

## Remarks:

(1) Including head one or more items from countersunk screws, self-tapping components, etc.

(2) The paper nameplate dimensions and quantity may vary with device model.

# 2 Overview

This guide introduces 2-button and 4-button door stations. The appearance, dimensions, and structure may vary with device model.

## 2.1 Dimensions

- 2-button

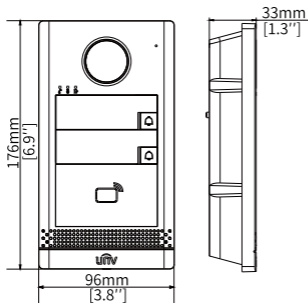

● 4-button

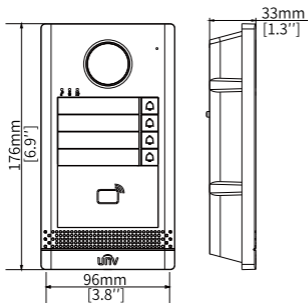

## 2.2 Structure

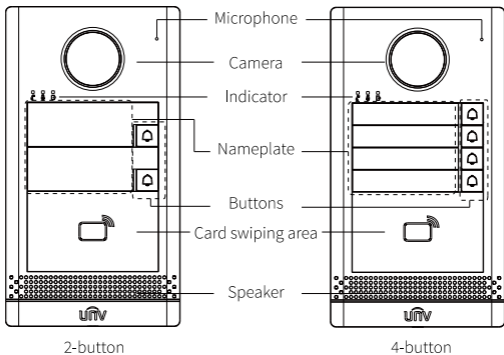

● Front View

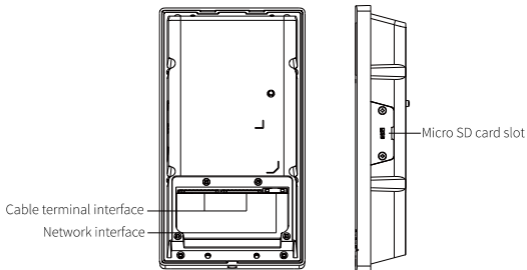

● Rear and Side View



## 2.3 Indicators

Indicator	Description
	Steady red: Calling
	Steady white: In a call
	Steady green: Door is open

## 3 Device Installation

The following figures are for reference only. The actual installation method may vary with scenarios.



### NOTE!

The installation methods of 2-button and 4-button door station are the same. The following takes the 4-button device as an example.

### 3.1 Preparation

- **Wiring:** Before installation, plan wiring for all cables based on the actual networking conditions.
- **Tools:** Prepare hardware tools, for example, Phillips screwdrivers.

## 3.2 Wall Mount



### NOTE!

- An 86\*86mm/115\*73mm junction box (self-prepared or purchased separately) can be used for wall mount. Please select a suitable box size based on the actual scenario.
- A sunshield (self-prepared or purchased separately) can be used for wall mount.

1. Mount the 86mm/115mm junction box (skip this step if no junction box ).

Use the existing 86mm/115mm junction box embedded in the wall or drill a recess to embed one. The two installation holes on the 86mm/115mm junction box should be parallel/vertical to the ground.

2. Paste the drill template.

- With junction box: Align the left and right holes (B) on the drill template with the two installation holes on the 86mm junction box, or align the top and bottom holes (B) with the holes on the 115mm junction box.
- Without junction box:
  - (1) Paste the drill template on the wall with the arrow perpendicular to the ground.
  - (2) Use a  $\varnothing 6\text{mm}$  to  $\varnothing 6.5\text{mm}$  drill bit to drill three 30mm-depth holes on the A position. Be careful not to damage cables in the wall.
  - (3) Insert the expansion bolts into the three holes.

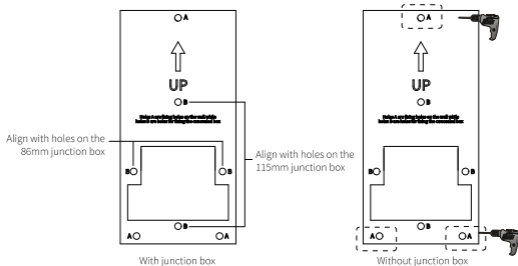

### 3. Mount the bracket.

- With junction box: Attach the bracket to the junction boxes by aligning the two center holes with the holes on the 86mm junction box, or aligning the top and bottom holes with the holes on the 115mm junction box, and then secure them with two round tail cross screws.
- Without junction box: Align the three slots on the bracket with the holes on the wall, and secure them with three pointed tail screws.

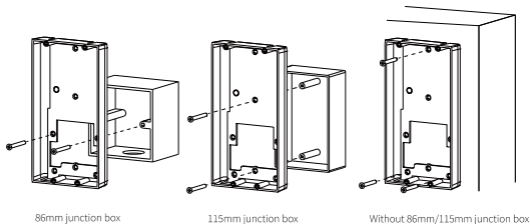

- ### 4. (Optional) Install the Micro SD card (self-prepared or purchased separately) if you want to save videos.



#### NOTE!

Do not hot plug the Micro SD card, otherwise the door station or the SD card may be damaged.

To install the Micro SD card, loose the screw on the card slot cover, insert a card, and then tighten the screw.

### 5. (Optional) Install the sunshield.

- (1) Insert the sunshield from the rear side of the door station.
- (2) Mount the rubber stopper to the arrow position of the bracket (protrusion position for the recess bracket) as shown in the right figure, which can prevent the tamper-proof button of the door station from continuously sounding due to loosening.

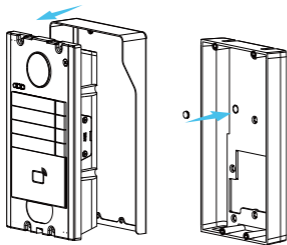

6. Connect all cables (self-prepared).

- (1) Loosen the screws of the cable cover on the rear panel, and then remove the cover.
- (2) Connect the network cable and power cable to the corresponding cable terminal correctly, and then connect other cables based on actual networking. For instructions on how to connect cable terminals, see the cable label on the device.
- (3) Fix the cable cover to the door station with screws.

7. Fix the door station onto the wall mount bracket.

Align the slots on the door station with the four holes of the bracket, and secure them with four long Torx screws.

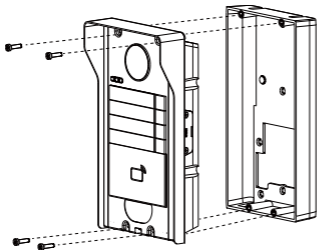

8. Fix the sunshield to the door station.

- (1) Insert the sunshield from the rear side of the station, secure them, and make sure the screw hole of the sunshield is aligned with the bottom screw hole of the door station.
- (2) Insert a short Torx screw into the bottom of the station, and then tighten it.

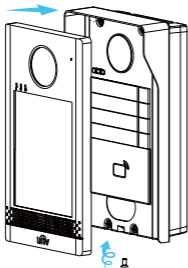

### 3.3 Recess Mount

1. Mount the recess bracket.

(1) Drill a recess and holes on the wall based on the recess bracket size.

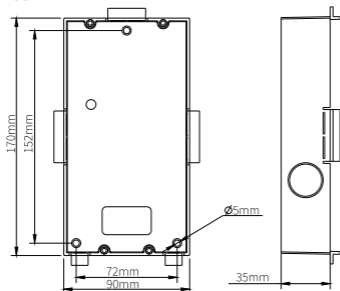

(2) Keep the recess bracket facing outward and upward, insert four pointed tail cross screws into inside holes to secure the bracket on the wall, and then remove the five limiting parts as shown in the circle position in the figure.

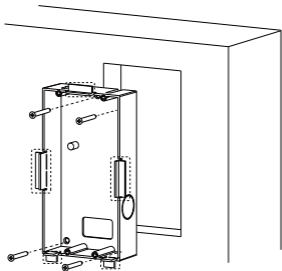

2. Complete the rest operations by referring to the steps 4 to 8 in [3.2 Wall Mount](#).

## 3.4 Nameplate Mount

1. Write down the information of the door station to be called on the paper nameplate, such as device location, household name, etc., so as to ensure that the callee can be distinguished from the nameplate content.
2. Remove the nameplate cover and base from the position marked with an arrow, and separate them.

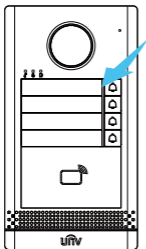

3. Tear off the nameplate written, put in into the middle of the cover and base (the side with the words facing outward), and then secure them to the door station.

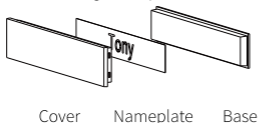

Cover      Nameplate      Base

## 4 Startup

Connect the device to the PoE power source through the network cable; or connect the device to the mains through the power adapter. The device will start when it is connected to power.

## 5 Default Settings

IP address  
**192.168.1.13**

Username/Password  
**admin/123456**

**Note:**

For security, please set a strong password of at least nine characters including all three elements: uppercase and lowercase letters, digits, and special characters. You are strongly recommended to regularly change the device password and keep it secure to ensure that only authorized users can log in.

## Disclaimer and Safety Warnings

### Copyright Statement

©2023 Zhejiang Uniview Technologies Co., Ltd. All rights reserved.

No part of this manual may be copied, reproduced, translated or distributed in any form or by any means without prior consent in writing from Zhejiang Uniview Technologies Co., Ltd (referred to as Uniview or us hereafter).

The product described in this manual may contain proprietary software owned by Uniview and its possible licensors. Unless permitted by Uniview and its licensors, no one is allowed to copy, distribute, modify, abstract, decompile, disassemble, decrypt, reverse engineer, rent, transfer, or sublicense the software in any form or by any means.

### Trademark Acknowledgements



are trademarks or registered trademarks of Uniview.

All other trademarks, products, services and companies in this manual or the product described in this manual are the property of their respective owners.

### Export Compliance Statement

Uniview complies with applicable export control laws and regulations worldwide, including that of the People's Republic of China and the United States, and abides by relevant regulations relating to the export, re-export and transfer of hardware, software and technology. Regarding the product described in this manual, Uniview asks you to fully understand and strictly abide by the applicable export laws and regulations worldwide.

### EU Authorised Representative

UNV Technology EUROPE B.V. Room 2945,3rd Floor,Randstad 21-05 G,1314 BD,Almere,Netherlands.

### Privacy Protection Reminder

Uniview complies with appropriate privacy protection laws and is committed to protecting user privacy. You may want to read our full privacy policy at our website and get to know the ways we process your personal information. Please be aware, using the product described in this manual may involve the collection of personal information such as face, fingerprint, license plate number, email, phone number, GPS. Please abide by your local laws and regulations while using the product.

### About This Manual

- This manual is intended for multiple product models, and the photos, illustrations, descriptions, etc, in this manual may be different from the actual appearances, functions, features, etc, of the product.
- This manual is intended for multiple software versions, and the illustrations and descriptions in this manual may be different from the actual GUI and functions of the software.
- Despite our best efforts, technical or typographical errors may exist in this manual. Uniview cannot be held responsible for any such errors and reserves the right to change the manual without prior notice.
- Users are fully responsible for the damages and losses that arise due to improper operation.
- Uniview reserves the right to change any information in this manual without any prior notice or indication. Due to such reasons as product version upgrade or regulatory requirement of relevant regions, this manual will be periodically updated.

### Disclaimer of Liability

- The product described in this manual is provided on an "as is" basis. Unless required by applicable law, this manual is only for informational purpose, and all statements, information, and recommendations in this manual are presented without warranty of any kind, expressed or implied, including, but not limited to, merchantability, satisfaction with quality, fitness for a particular purpose, and noninfringement.
- To the extent allowed by applicable law, in no event shall Uniview's total liability to you for all damages for the product described in this manual (other than as may be required by applicable law in cases involving personal injury) exceed the amount of money that you have paid for the product.

- Users must assume total responsibility and all risks for connecting the product to the Internet, including, but not limited to, network attack, hacking, and virus. Uniview strongly recommends that users take all necessary measures to enhance the protection of network, device, data and personal information. Uniview disclaims any liability related thereto but will readily provide necessary security related support.
- To the extent not prohibited by applicable law, in no event will Uniview and its employees, licensors, subsidiary, affiliates be liable for results arising out of using or inability to use the product or service, including, not limited to, loss of profits and any other commercial damages or losses, loss of data, procurement of substitute goods or services; property damage, personal injury, business interruption, loss of business information, or any special, direct, indirect, incidental, consequential, pecuniary, coverage, exemplary, subsidiary losses, however caused and on any theory of liability, whether in contract, strict liability or tort (including negligence or otherwise) in any way out of the use of the product, even if Uniview has been advised of the possibility of such damages (other than as may be required by applicable law in cases involving personal injury, incidental or subsidiary damage).

### Network Security

#### Please take all necessary measures to enhance network security for your device.

The following are necessary measures for the network security of your device:

- **Change default password and set strong password:** You are strongly recommended to change the default password after your first login and set a strong password of at least nine characters including all three elements: digits, letters and special characters.
- **Keep firmware up to date:** It is recommended that your device is always upgraded to the latest version for the latest functions and better security. Visit Uniview's official website or contact your local dealer for the latest firmware.
- **The following are recommendations for enhancing network security of your device:**
- **Change password regularly:** Change your device password on a regular basis and keep the password safe. Make sure only the authorized user can log in to the device.
- **Enable HTTPS/SSL:** Use SSL certificate to encrypt HTTP communications and ensure data security.
- **Enable IP address filtering:** Allow access only from the specified IP addresses.
- **Minimum port mapping:** Configure your router or firewall to open a minimum set of ports to the WAN and keep only the necessary port mappings. Never set the device as the DMZ host or configure a full cone NAT.
- **Disable the automatic login and save password features:** If multiple users have access to your computer, it is recommended that you disable these features to prevent unauthorized access.
- **Choose username and password discretely:** Avoid using the username and password of your social media, bank, email account, etc, as the username and password of your device, in case your social media, bank and email account information is leaked.
- **Restrict user permissions:** If more than one user needs access to your system, make sure each user is granted only the necessary permissions.
- **Disable UPnP:** When UPnP is enabled, the router will automatically map internal ports, and the system will automatically forward port data, which results in the risks of data leakage. Therefore, it is recommended to disable UPnP if HTTP and TCP port mapping have been enabled manually on your router.
- **Multicast:** Multicast is intended to transmit video to multiple devices. If you do not use this function, it is recommended you disable multicast on your network.
- **Check logs:** Check your device logs regularly to detect unauthorized access or abnormal operations.
- **Isolate video surveillance network:** Isolating your video surveillance network with other service networks helps prevent unauthorized access to devices in your security system from other service networks.
- **Physical protection:** Keep the device in a locked room or cabinet to prevent unauthorized physical access.
- **SNMP:** Disable SNMP if you do not use it. If you do use it, then SNMPv3 is recommended.

**Learn More**

You may also obtain security information under Security Response Center at Uniview's official website.

### **Safety Warnings**

The device must be installed, serviced and maintained by a trained professional with necessary safety knowledge and skills. Before you start using the device, please read through this guide carefully and make sure all applicable requirements are met to avoid danger and loss of property.

### **Storage, Transportation, and Use**

- Store or use the device in a proper environment that meets environmental requirements, including and not limited to, temperature, humidity, dust, corrosive gases, electromagnetic radiation, etc.
- Make sure the device is securely installed or placed on a flat surface to prevent falling.
- Unless otherwise specified, do not stack devices.
- Ensure good ventilation in the operating environment. Do not cover the vents on the device. Allow adequate space for ventilation.
- Protect the device from liquid of any kind.
- Make sure the power supply provides a stable voltage that meets the power requirements of the device. Make sure the power supply's output power exceeds the total maximum power of all the connected devices.
- Verify that the device is properly installed before connecting it to power.
- Do not remove the seal from the device body without consulting Uniview first. Do not attempt to service the product yourself. Contact a trained professional for maintenance.
- Always disconnect the device from power before attempting to move the device.
- Take proper waterproof measures in accordance with requirements before using the device outdoors.

### **Power Requirements**

- Install and use the device in strict accordance with your local electrical safety regulations.
- Use a UL certified power supply that meets LPS requirements if an adapter is used.
- Use the recommended cordset (power cord) in accordance with the specified ratings.
- Only use the power adapter supplied with your device.
- Use a mains socket outlet with a protective earthing (grounding) connection.
- Ground your device properly if the device is intended to be grounded.

### **Battery Use Caution**

- When battery is used, avoid:
  - Extremely high or low temperature and air pressure during use, storage and transportation.
  - Battery replacement.
- Use the battery properly. Improper use of the battery such as the following may cause risks of fire, explosion or leakage of flammable liquid or gas.
  - Replace battery with an incorrect type;
  - Dispose of a battery into fire or a hot oven, or mechanically crushing or cutting of a battery;
- Dispose of the used battery according to your local regulations or the battery manufacturer's instructions.

### **Avertissement de l'utilisation de la batterie**

- Lorsque utiliser la batterie, évitez:
  - Température et pression d'air extrêmement élevées ou basses pendant l'utilisation, le stockage et le transport.
  - Remplacement de la batterie.
- Utilisez la batterie correctement. Mauvaise utilisation de la batterie comme celles mentionnées ici, peut entraîner des risques d'incendie, d'explosion ou de fuite liquide de gaz inflammables.
  - Remplacer la batterie par un type incorrect;
  - Disposer d'une batterie dans le feu ou un four chaud, écraser mécaniquement ou couper la batterie;
- Disposer la batterie utilisée conformément à vos règlements locaux ou aux instructions du fabricant de la batterie.

### **Regulatory Compliance**

#### **FCC Statements**

This device complies with Part 15 of the FCC Rules. Operation is subject to the following two conditions: (1) this device may not cause harmful interference, and (2) this device must accept any interference received, including interference that may cause undesired operation.

Visit [http://en.uniview.com/Support/Download\\_Center/Product\\_Installation/Declaration/](http://en.uniview.com/Support/Download_Center/Product_Installation/Declaration/) for SDoC.

**Caution:** The user is cautioned that changes or modifications not expressly approved by the party responsible for compliance could void the user's authority to operate the equipment.

**NOTE:** Note: This product has been tested and found to comply with the limits for a Class B digital device, pursuant to Part 15 of the FCC Rules. These limits are designed to provide reasonable protection against harmful interference in a residential installation. This product generates, uses, and can radiate radio frequency energy and, if not installed and used in accordance with the instructions, may cause harmful interference to radio communications. However, there is no guarantee that interference will not occur in a particular installation. If this product does cause harmful interference to radio or television reception, which can be determined by turning the equipment off and on, the user is encouraged to try to correct the interference by one or more of the following measures:

- Reorient or relocate the receiving antenna.
- Increase the separation between the equipment and receiver.
- Connect the equipment into an outlet on a circuit different from that to which the receiver is connected.
- Consult the dealer or an experienced radio/TV technician for help.

#### LVD/EMC Directive



This product complies with the European Low Voltage Directive 2014/35/EU and EMC Directive 2014/30/EU.

#### WEEE Directive—2012/19/EU



The product this manual refers to is covered by the Waste Electrical & Electronic Equipment (WEEE) Directive and must be disposed of in a responsible manner.

#### Battery Directive-2013/56/EU



Battery in the product complies with the European Battery Directive 2013/56/EU. For proper recycling, return the battery to your supplier or to a designated collection point.