

VEVOR[®]

Mini Grinder
User Manual

VEVOR[®]

Mini Grinder User Manual

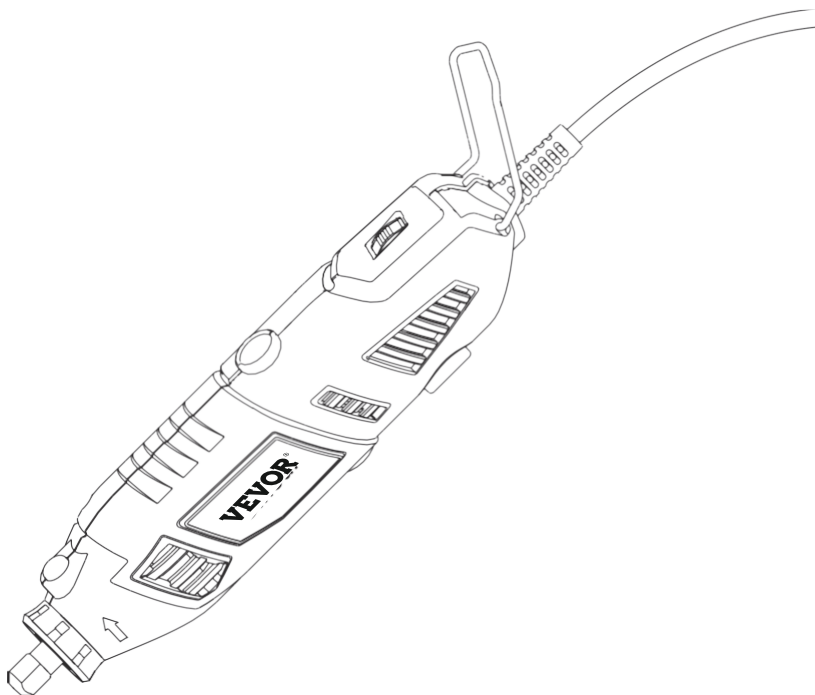

NEED HELP? CONTACT US!

Have product questions? Need technical support? Please feel free to contact us:

✉ CustomerService@vevor.com

This is the original instruction, please read all manual instructions carefully before operating. VEVOR reserves clear interpretation of our user manual. The appearance of the product shall be subject to the product you received. Please forgive us that we won't inform you again if there is any technology or software updates on our product.

INTRODUCTION

This rotary tool can be used for drilling, grinding, sanding and polishing, as well as engraving, cutting and removing rust in tight spaces or inaccessible places. The tool can be used on most metals, glass, wood and ceramics. For best performance and results keep the speed as even as possible without exercising too much pressure. As a guideline, use the tool at low speed for all large accessories, such as polishing for example, and at high speed for smaller accessories such as those used for engraving. For grinding and engraving, hold the tool as if it were a pen.

TECHNICAL SPECIFICATIONS

Available Voltages	120V 60Hz
Maximum Output	160W 1.4A
No Load Speed	8,000 - 35,000 rpm
Collet chuck capacity	Max3.2mm dia.

SAFETY INSTRUCTIONS FOR ALLTOOLS

WARNING: When using electric power tools, important safety precautions must always be adhered to in order to reduce the risk of fire, electric shock and personal injury.

Please Read The Following Carefully:

1. KEEP WORK AREA CLEAN. Untidy benches and work areas invite injuries.
2. CONSIDER WORK AREA ENVIRONMENT. Do not use power tools in damp or wet locations. Do not expose power tools to rain. Keep work areas well lit.
3. GUARD AGAINST ELECTRIC SHOCK. Prevent body contact with grounded surfaces. Eg. Radiators, pipes, refrigerator enclosures.
4. KEEP CHILDREN AWAY. All visitors must be kept away from the work area. Do not let visitors come into contact with the tool or extension cord.
5. STORE IDLE TOOLS. When not in use, tools must be stored in a dry place, out of reach of children.
6. DO NOT FORCE THE TOOL. It will do the job at hand better and safer at the rate for which it was intended.
7. USE THE RIGHT TOOL. Do not force a small tool to do the job of a heavy-duty power tool. Do not use the tool for the purpose it is not intended for.
8. DRESS PROPERLY. Do not wear loose clothing or jewelry, as these can be caught in moving parts. Gloves and non-skid footwear are recommended when working outdoors. Wear a protective head cover to contain long hair.

9. USE SAFETY GLASSES. Also use a face and a dust mask to guard against dust.
10. DO NOT ABUSE THE CORD. Never carry the tool by the cord or pull the cord to disconnect the tool. Keep the cord away from heat, oil or sharp objects.
11. SECURE YOUR WORK. Use clamps or a vice to hold your work in position. It is much safer than using your hand and it frees both hands to operate the tool.
12. DO NOT OVERREACH. Keep proper footing and balance at all times.
13. MAINTAIN TOOLS WITH CARE. Keep tools clean for better and safer performance. Follow instructions for lubricating and changing accessories. Keep hands dry, clean and free from oil and grease.
14. DISCONNECT TOOLS. When not in use, before servicing and when changing any accessories.
15. REMOVE ADJUSTING KEYS AND WRENCHES. Have the habit to check and see that keys and adjusting wrenches are removed from the tool before turning it on.
16. AVOID UNINTENTIONAL STARTING. Do not carry plugged-in tool with finger on switch. Be sure that the switch is off when plugging in.
17. OUTDOOR EXTENSION CORDS. When the tool is used outdoors, only use extension cords intended for use outdoors and so marked.
18. STAY ALERT. Watch what you are doing. Use common sense. Do not operate the tool when you are tired.
19. CHECK DAMAGED PARTS. Before using a tool, protective cover, or other damaged part, these must be carefully checked to ensure that the tool will perform properly the intended function. Check for alignment of moving parts, binding of moving parts, breakage of parts, mounting and any other condition that may affect the tool's operation.
20. DO NOT OPERATE portable electric tools near flammable liquids or in gaseous or explosive atmospheres. Motors in these tools normally spark, and the sparks may ignite fumes.

Multifunction Power Tool Start-up

Never start up or stop the tool when the accessory is in contact with the piece. Hold it firmly and press the ON/OFF switch. The tool will run continuously until the switch is turned to OFF position. The speed can be adjusted while the tool is running.

Speed Adjustment

The multifunction power tool is equipped with speed control. Do not change the speed while the tool is working. The speed switch is located on the rear of the tool. Turn it to increase or reduce speed. Use the tool at a low speed for polishing and similar operations, but use a higher speed for drilling or cutting action.

Important General Safety Tips!

1. The Tool should be unplugged when changing accessories.
2. If you stall the tool, switch it off immediately.
3. Periodically check the tightness of your collet chuck, especially during prolonged use of the same accessory.
4. After use, always disconnect your power tool.
5. Do not undertake repair of the power tool yourself.

6. Do not leave your tool unattended while switched on.
7. Do not use or store your tool in damp or wet conditions.

Useful Hints & Tips

1. Your rotary tool will become warm after prolonged use and so must be switched off and allowed to cool down.
2. To ensure smooth running, the spindle should be oiled periodically.
3. Do not apply too much radial pressure to the accessory bits while polishing, cleaning, sanding or grinding. By doing this you will put a strain on the spindle and adversely affect the precision of the tool.
4. Always work with a sensitive touch so as not to impede the efficiency of your mini tool.
5. When drilling metal, always mark the drilling point with a center punch first, so that your rotary tool does not slip.
6. Always ensure that you have maximum contact between the accessory shaft and the collet chuck.
7. Vary the speed of the tool for the work in hand, eg. Low speed for polishing & cleaning and high speed for engraving.

Placing Accessories Into The Tool

Always switch the tool off first. Hold the locking button at the front of the tool down and undo the collet chuck (anti-clock-wise). Insert the collet that matches the shaft size of the accessory to be used. Place the collet nut over the collet and then insert the accessory shaft into the collet chuck ensuring maximum shaft contact. Then tighten up the collet nut. (DO NOT USE PLIERS).

KNOW YOUR ROTARY TOOL

Before attempting to use any tool, familiarize yourself with all operating features and safety requirements.

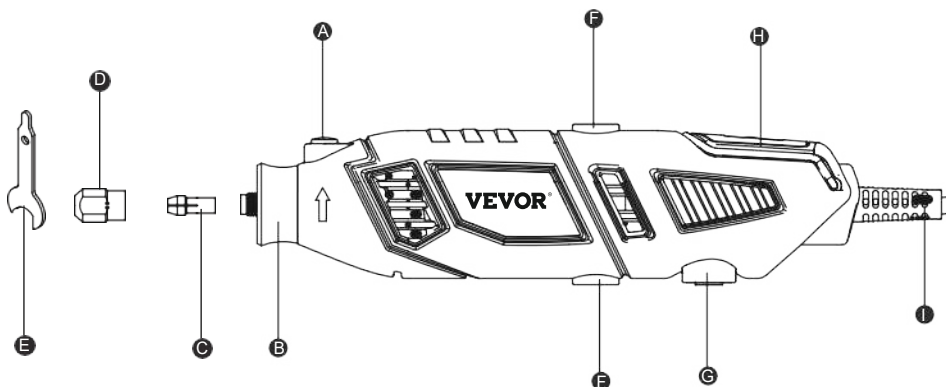

PART	DESCRIPTION
A	Shaft lock button
B	Case Lock
C	Collet
D	Collet nut
E	Collet wrench
F	Brush cap
G	On/Off Switch
H	Speed control dial
I	Power cord

FUNCTION DESCRIPTION

On / Off Switch

This product has an easy access power switch (H) located at the bottom of the tool.

Need to adjust the speed of the work can rotate the G speed switch

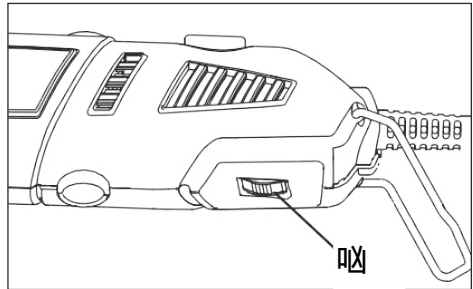

Replacing Collets

Using collets is the most precise way to hold an accessory in a high-speed rotation. Even at high speeds and maximum pressure, collets stay tight.

1. Unplug the rotary tool.
2. Press and hold the shaft lock button(A), and rotate the shaft with the provided collet wrench (E) until the shaft lock (A) engages the shaft, preventing further rotation.
3. With the shaft lock (A) engaged, use the collet wrench (E) to loosen the collet nut (D), if necessary.
4. Remove the collet nut (D) and old collet (C) using the collet wrench (E), if necessary.
5. Insert the unslotted end of the new collet (C) in the hole at the end of the tool shaft.
6. Tighten the collet nut with the collet wrench (E).

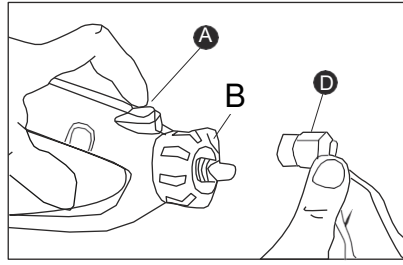
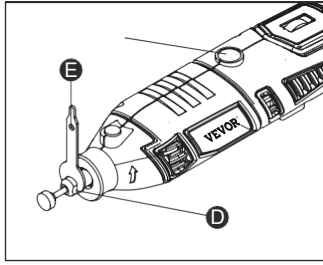

Installing Accessories



WARNING

Do not press the shaft lock button (A) while rotary tool is running.

1. Unplug the rotary tool.
2. Press and hold the shaft lock button(A), and rotate the shaft by hand until the shaft lock engages the shaft, preventing further rotation.
3. With the shaft lock button engaged, use the collet wrench (E) to loosen the collet nut (D), if necessary.
4. Insert the shank of the accessory into the collet as deep as possible. With the shaft lock (A) engaged, tighten.
5. the collet nut (D) with the provided wrench (E) until the accessory shank is gripped by the collet. Avoid
6. excess tightening of the collet nut (D).

Removing Accessories

1. Unplug the rotary tool.
2. With the shaft lock (A) engaged, loosen the collet nut (D) with the provided wrench (E).
3. Remove the accessory.

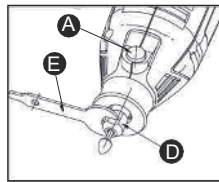

Using Mandrels

The most common types of mandrel to use with this tool are the standard mandrel which is used with cutoff discs, grinding wheels, emery wheels, and cut-off wheels. Screw mandrels are used with polishing wheels and polishing drums. Drum mandrel are used with sanding drums.

TO INSTALL:

1. Unplug the rotary tool
2. Install the mandrel.

If Using The Standard Mandrel:

1. Press and hold the shaft lock button (A).
2. Insert the slot end of the provided wrench into the slot on top of the mandrel and unscrew.
3. Remove mandrel screw and washer.
4. Place desired accessory over mandrel shaft and align accessory hole with mandrel hole.
5. Insert mandrel screw with washer through the accessory and mandrel shaft holes.

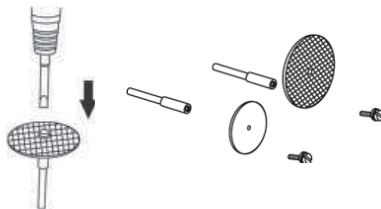

NOTE: The mandrel washer should be placed between the mandrel screw and the accessory.

* Tighten using provided wrench.

If Using The Drum Mandrel:

1. Align appropriate sized sanding drum over mandrel and push down to completely cover drum end of mandrel.
2. Insert the slot end of the provided wrench into the slot on top of the mandrel and tighten the screw on the drum mandrel head to expand the drum and securely hold the sanding drum in place.

If Using The Screw Mandrel:

1. Align desired accessory hole with mandrel screw head.
2. Screw accessory onto mandrel by twisting clockwise until secure.



Balancing Accessories

For precision work, it is important that all accessories be properly balanced. To balance an accessory, slightly loosen the collet nut and give the accessory or collet a 1/4 in. turn. Retighten collet nut and run the rotary tool. You should be able to judge by the sound and feel if the accessory is running in balance. Continue adjusting in this fashion until the best balance is achieved. Replace accessories if they become damaged or unbalanced.

Speed Control





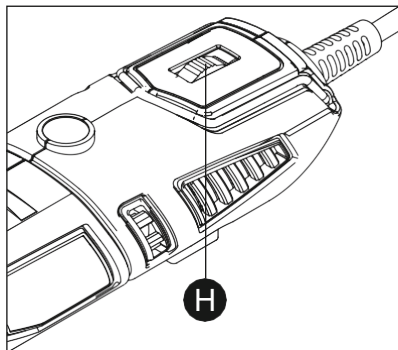

The rotary tool has a speed range of 8,000 to 35,000 RPM.

To select the right speed for each job, use a practice piece of material.

Vary speed to find the best speed for the accessory you are using and the job to be done. Use the indicator mark above the speed control dial (H) to set the best speed for the job. The speed control dial (H) is numbered from 1 to 6. For example, a speed setting of 1 is approximately 8,000 RPM, and a speed setting of 6 is approximately 35,000 RPM. Refer to the Speed Dial Settings table to determine the proper speed based on the material being worked and the type of accessory being.



SPEED SETTING FOR ROTARY ACCESSORIES

Function	Picture	Accessory Description	Soft wood	Hard wood	Plastic	Steel	Aluminum, brass, etc.	Shell, stone	Ceramic	Glass
Polished Debrurr		Grinding wheel	15000-35000	15000-35000	15000-35000	15000-35000	15000-35000	15000-35000	15000-35000	/
		Diamond Grinding Needle	/	/	/	/	/	20000-35000	20000-35000	20000-35000
		Sanding band	15000-35000	15000-35000	15000-35000	15000-35000	15000-35000	15000-35000	15000-35000	/
Drilling		Drill bits	15000-35000	15000-35000	15000-25000	/	/	/	/	/
Polishing		Wool felt wheel	/	/	/	12000-17000	12000-17000	12000-17000	12000-17000	12000-17000
		Sanding paper	12000-20000	12000-20000	12000-20000	/	12000-20000	/	/	/
Cleaning		Stainless brush	8000-15000	8000-15000	8000-15000	8000-15000	8000-15000	/	/	/
Cutting		Cut off wheel	/	/	25000-35000	25000-35000	25000-35000	25000-35000	/	/
Switch Setting	1	2	3			4		5		5
Speed Range	8000-11000 RPM	11000-13000RPM		14000-16000RPM		17000-20000RPM		22000-28000RPM		29000-35000 RPM

RULES OF OPERATING SPEEDS

The best way to determine the correct speed for work on any material is to practice for a few minutes on a piece of scrap, even after referring to the Speed Dial Settings tables. You can quickly learn that a slower or faster speed is more effective just by observing what happens when you make a pass or two at different speeds.

When working with a scrap piece of plastic, start at a slow rate of speed and increase the speed until you observe whether the plastic is melting at the point of contact; reduce the speed slightly to get optimum working speed without melting the workpiece.

Certain materials, some plastics for example, require a relatively slow speed because at high speed the friction of the tool generates heat and causes the plastic to melt.

Slow speed operation (15,000 RPM or less) is usually best for polishing operations using the felt polishing accessories, delicate wood carving and fragile model parts. All brush applications require lower speeds to avoid wire discharge from the holder. Allow the tool to do the work for you when using lower speed settings.

Higher speeds are better for drilling, carving, cutting, routing, shaping, and cutting dadoes or rabbets in wood. Hardwoods, metals and glass also require high speed operation.

NOTE:

1. Plastic and materials that could melt at low temperatures should be cut at low speeds.
2. Soft wood should be cut at high speed.
3. Aluminum, tin, copper, lead, and zinc alloys may be cut at any speed, depending on the type of cutting being done. Use paraffin or other suitable lubricant on the cutter to prevent the cut material from adhering to the cut.

CUTTING GUIDE

The cutting guide comes completely assembled and ready to use on a variety of materials up to 20mm thick. Always hold the tool firmly, using a slow steady pressure to guide the tool through your work. The speed of the tool will do the work.

IMPORTANT: Always cut in clockwise direction except when following a template (outlet box), then cut in counter clockwise direction.

Installation Instruction Of The Cutting Guide Attachment

Step 1 & 2. Remove the collet nut and then the housing cap from the end of your rotary tool.

Step 3. Place the collet nut loosely on the end of the rotary tool and insert the cutting bit.
Tighten collet nut.

Step 4. Thread the Cutting Guide Attachment onto the exposed housing threads on the rotary tool.

Step 5. Adjust the attachment to the desired cutting depth.

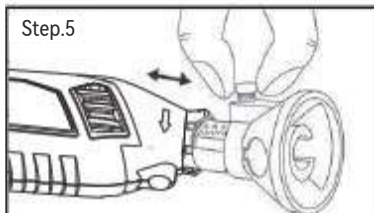
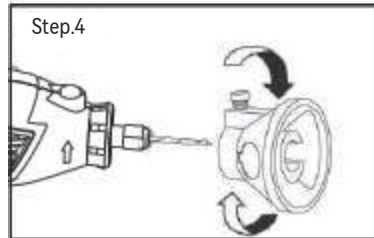
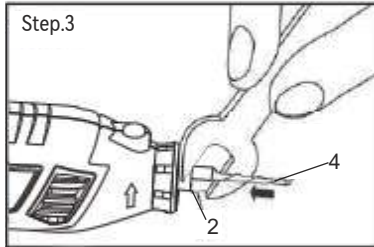
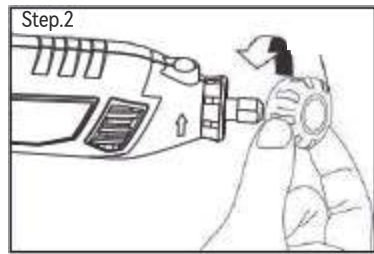
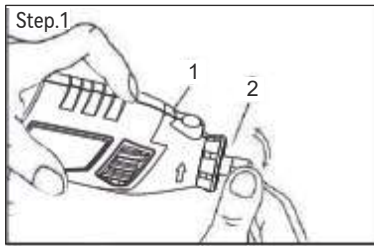

Shield Rotary Tool Attachment

The rotary shield attachment provides a clear and simple solution for redirecting debris and sparks away from the user without interfering with the task at hand. The tool shield can be used with right-hand or left-hand grip positions and works to deflect debris on a variety of applications, including cutting, sanding, grinding and polishing. The shield can be quickly adjusted into position, provides easy access to the accessory without interfering with the workpiece.

Installation Instruction:

- Step 1. Remove the housing cap A from the end of the tool and set housing cap aside. The original housing cap must be reinstalled when this attachment is not used (Fig.1).
- Step 2. Screw the Shield onto the tool using the lock nut B(Fig.2).
- Step 3. Position the Shield such that it will redirect debris, sparks, and dust away from the user using the positioning tabs C (Fig.3).

Using The Shield Rotary Tool Attachment

Always turn the tool off before adjusting position, changing accessory and removing attachment. Rotary Tools cut, sand, grind, and polish in many directions. To accommodate the Rotary Tool's Maneuverability, the Shield can be quickly positioned and repositioned with a turn to the right or left . To extend the service life of the shield, it should be cleaned regularly with a soft brush or compressed air. ■

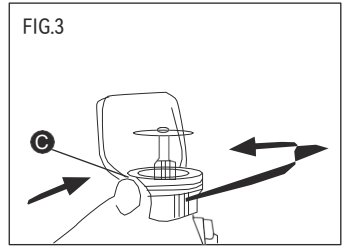
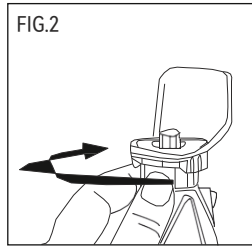
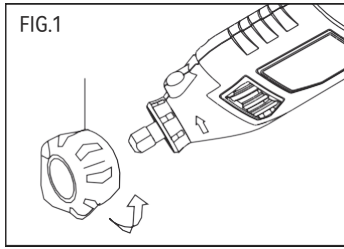

Flexible Driver Attachment

Safety Rules for Flexible Driver. Do not operate the flexible shaft with a sharp or multiple bends. Ensure that there are no sharp residual bends or kinks in the Flexible Driver before the operation. Overbending the shaft can generate excessive heat on the jacket or handpiece and may cause the Flexible Driver to disengage from the tool. The minimum recommended bend radius is 6". Always hold the handpiece firmly in your hands during the start-up. The reaction torque of the motor, as it accelerates to full speed, can cause the shaft to twist. Not for use with router bits or other large diameters (1" or larger) bits. Large diameter bits can cause kickback and loss of control when used with the Flexible Driver. Do not remove the end ferrule while tool is running. The cable will become loose from the jacket and will uncontrollably whip or lash around.

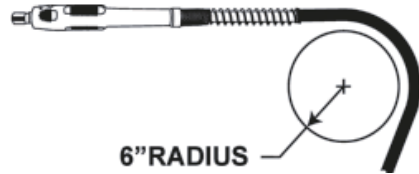

INSTALLATION DIAGRAM OF FLEXIBLE DRIVER

1. Remove the shaft collar.

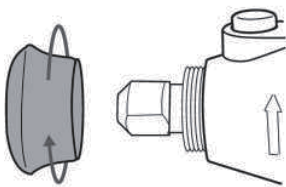

2. Loosen the collet nut.

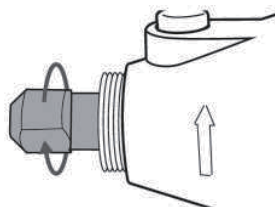

3. Raise the handle end of the flexible shaft & shake gently until the inner flexible shaft protrudes.

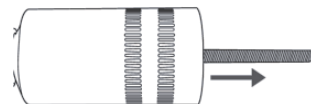

4. Insert the inner flexible shaft into the collet then tighten the collet.

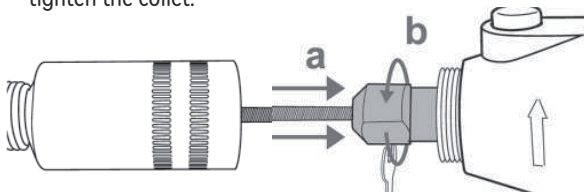

5. Screw the flexible shaft fitting collar onto the rotary tool.



6. Insert the hex key into the hole on the handle.

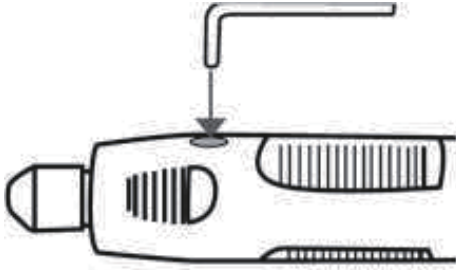

7. Loosen collet nut then insert shank of accessory into collet.

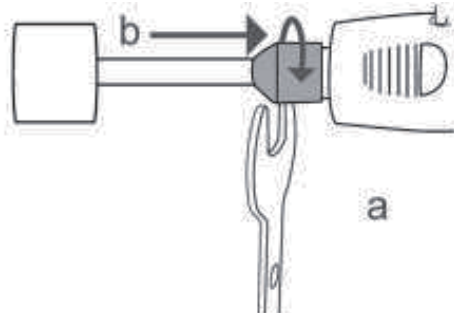

DIRECTIONS FOR USE

1. With small milling cutters / grinding pins: Use a high speed.
2. With large milling cutters / grinding pins: Use a low speed.
3. Precision work / engraving: Hold the drive unit like a pen.
4. Rough work: Hold the drive unit like a hammer.

TIPS:

1. Exert only moderate pressure on the workpiece and allow it to be processed at uniform speed.
2. You will not finish your work sooner by exerting heavy pressure. On the contrary, heavy pressure will cause the drive unit to slow down or stop and will overload the motor.

Operating Instructions

Run-In before Operation

For optimum performance, allow your new Flexible Driver attachment to run at high speed on your rotary tool in a vertical position for 2 minutes before use (Fig. 1).

Disengagement of the Flexible Driver

The flexible shaft may become disengaged if the motor of your rotary tool is not elevated.

Higher than the working end of the Flexible Driver.

Flexible Shaft Lubrication

The Flexible Driver should be lubricated after every 25-30 hours of use. To lubricate, Unscrew the Flexible Driver assembly from the motor housing. Pull the center core out of the Flexible Driver assembly. Wipe a very thin film of automotive wheel bearing grease onto the center core and reinsert it back into the shaft. To prevent damage to tool do not over grease shaft. Too much grease will cause the unit to overheat. Reattach the Flexible Driver to the rotary tool.



Fig.1

CLEANING

1. Keep all safety devices, air vents and the motor housing free of dirt and dust as far as possible. Wipe the equipment with a clean cloth or blow it with compressed air at low pressure.
2. We recommend that you clean the device immediately each time you have finished using it.
3. Clean the equipment regularly with a moist cloth and some soft soap. Do not use cleaning agents or solvents; these could attack the plastic parts of the equipment. Ensure that no water can seep into the device.



Read the instruction manual.



This product is of protection class II. That means it is equipped with enhanced or double insulation.



Compliance is a North n security certification.

Manufacturer: Changzhou Wujin Dacheng Industry & Trade Co., Ltd
Add: Niutang Town, Wujin, Jiangsu, 213163

VEVOR[®]

E-mail: CustomerService@vevor.com