

# **VEVOR<sup>®</sup>**

**TOUGH TOOLS, HALF PRICE**

Technical Support and E-Warranty Certificate [www.vevor.com/support](http://www.vevor.com/support)

## **HEDGE TRIMMER INSTRUCTION MANUAL**

# **VEVOR<sup>®</sup>**

**TOUGH TOOLS, HALF PRICE**

**Technical Support and E-Warranty Certificate**

**[www.vevor.com/support](http://www.vevor.com/support)**

We continue to be committed to provide you tools with competitive price. "Save Half", "Half Price" or any other similar expressions used by us only represents an estimate of savings you might benefit from buying certain tools with us compared to the major top brands and does not necessarily mean to cover all categories of tools offered by us. You are kindly reminded to verify carefully when you are placing an order with us if you are actually saving half in comparison with the top major brands.



## ENVIRONMENTALLY SAFE BATTERY DISPOSAL

The batteries used in this hedge trimmer's battery pack contain the following toxic and corrosive material:

LITHIUM-ION.



**WARNING:** Toxic materials must be disposed of in a specified manner in order to prevent contamination of the environment. Before disposing of damaged or worn out Lithium-Ion battery packs, contact your local waste disposal agency for information and specific instructions. Take the batteries to a local recycling and/or disposal center that is certified for disposal. If the battery pack cracks or breaks, whether it leaks or not, do not recharge it and do not use it. Dispose of it and replace it with a new battery pack. **DO NOT ATTEMPT TO REPAIR IT!**

Follow these instructions in order to avoid injury and the risk of fire, explosion, or electric shock, and to avoid damage to the environment:

- Cover the battery's terminals with heavy-duty adhesive tape.
- Do not attempt to remove or destroy any of the components of the battery pack.
- Do not attempt to open the battery pack.
- If a leak develops, the electrolytes that are released are corrosive and toxic. Do not get the solution in the eyes or on the skin, and do not swallow it.
- Do not place batteries in regular household trash.
- DO NOT incinerate batteries.
- DO NOT place batteries where they will become part of any waste landfill or municipal solid waste stream.
- Dispose of batteries at a certified recycling or disposal center.

**VEVOR**<sup>®</sup>  
TOUGH TOOLS, HALF PRICE

Hedge Trimmer

MODEL:SF8A609

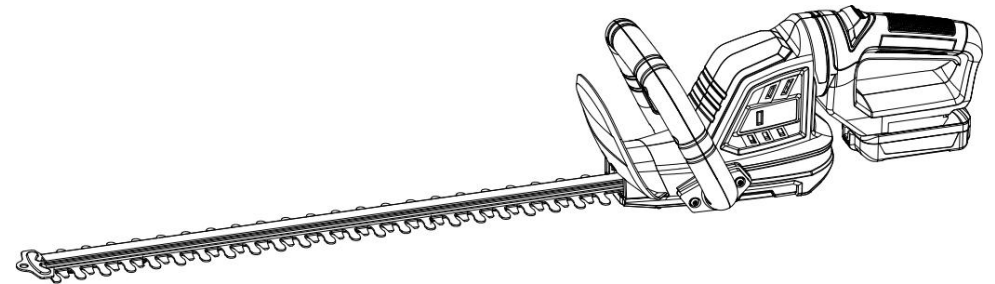

### NEED HELP? CONTACT US!

Have product questions? Need technical support? Please feel free to contact us:



**CustomerService@vevor.com**

This is the original instruction, please read all manual instructions carefully before operating. VEVOR reserves a clear interpretation of our user manual. The appearance of the product shall be subject to the product you received. Please forgive us that we won't inform you again if there are any technology or software updates on our product.

## CONTENTS

Technical data.....	2
Introduction.....	3
Safety information.....	3
General safety rules.....	4
Specific safety rules for hedge trimmer.....	10
Symbols.....	11
Knowing your hedge trimmer.....	12
Assembly.....	13
Operating instruction.....	15
Maintenance.....	17
Environmentally safe battery disposal.....	18

## TECHNICAL DATA

Max Cutting diameter:	16mm
Blade gap	16mm
Motor:	20V DC
No load speed:	3000 SPM
Battery type:	20V Lithium-ion
Battery model:	VV-SP2020
Battery capacity:	2.0Ah
Charger Input:	100-240V 50/60Hz
Charger Output:	21V DC,2A
Charging time	Approx 1hour
Package dimensions (L x W x H):	40.6 x8.7x7.9 inches
Weight:	9.0 lbs

- Clean the hedge trimmer thoroughly before storing. Store the hedge trimmer indoors, in a dry place that is inaccessible to children. Keep away from corrosive agents such as garden chemicals and deicing salts.

### LUBRICATING THE BLADE



**WARNING:** Always allow the blades of the hedge trimmer to come to a stop and remove the battery before lubricating. Failure to do so could result in accidental starting causing possible serious personal injury.

For easier operation and longer blade life, lubricate the hedge trimmer blade before and after each use.

- Remove the battery pack from the hedge trimmer.
- Lay the hedge trimmer on a flat surface. Apply light weight machine oil along the edge of the top blade.

**NOTE:** If you will be using the hedge trimmer for an extended time, it is advisable to oil the blade periodically.

- Stop the hedge trimmer.
- Remove the battery pack.
- Lubricate the hedge trimmer as described above.
- Re-install the battery pack and resume use.

### CLEANING THE HEDGE TRIMMER

- Remove the battery pack.
- Slide the scabbard over the blade.
- Clean dirt and debris from the body of the hedge trimmer, using a damp cloth with a mild detergent.

**NOTE:** Do not use any strong detergents on the plastic housing or the handle. They can be damaged by certain aromatic oils such as pine and lemon, and by solvents such as kerosene.

- Moisture can cause a shock hazard. Wipe off any moisture with a soft dry cloth.
- Use a small brush or the air discharge of a small vacuum cleaner brush to clear dust or debris from the blade on the motor housing.

## MAINTENANCE



**WARNING:** To avoid serious personal injury, always remove the battery pack from the product before inspecting, cleaning or performing any maintenance.



**WARNING:** Always wear eye protection with side shields marked to comply with ANSI Z87.1. If operation is dusty, also wear a dust mask.



**WARNING:** When servicing, use only identical replacement parts. Use of any other parts may create a hazard or cause product damage.



**WARNING:** Never use water or any liquids to clean or rinse off your product and do not expose the product to rain or wet conditions. Store indoors in a dry area. Corrosive liquids, water, and chemicals can enter the product's electronic components and cause damage, which can result in a short circuit, increased risk of fire, and serious personal injury. Remove any buildup of dirt and debris by wiping the product clean with a dry cloth occasionally.

**Note:** Periodically inspect the entire product for damaged, missing, or loose parts such as screws, nuts, bolts, caps, etc. Tighten securely all fasteners and caps and do not operate this product until all missing or damaged parts are replaced.

### GENERAL MAINTENANCE

Avoid using solvents when cleaning plastic parts. Most plastics are susceptible to damage from various types of commercial solvents and may be damaged by their use. Use clean cloths to remove dirt, dust, oil, grease, etc.

Do not at any time let brake fluids, gasoline, petroleum based products, penetrating oils, etc., come in contact with plastic parts. Chemicals can damage, weaken or destroy plastic which may result in serious personal injury.

### STORING

- Always place the scabbard on the blade before storing or transporting the hedge trimmer. Use caution to avoid the sharp teeth of the blade.

## INTRODUCTION

Thank You for Purchasing a ZEGJAW® Product. This manual provides information regarding the safe operation and maintenance of this product. Every effort has been made to ensure the accuracy of the information in this manual. ZEGJAW® reserves the right to change this product and specifications at any time without prior notice.

Please keep this manual available to all users during the entire life of the hedge trimmer.



This manual contains special messages to bring attention to potential safety concerns, hedge trimmer damage as well as helpful operating and servicing information. Please read all the information carefully to avoid injury and machine damage.

### QUESTIONS? PROBLEMS?

Please contact our Customer Service Dept. with any questions and/or comments, either by Email: [support@dgiproduct.com](mailto:support@dgiproduct.com)

## SAFETY INFORMATION

Before operating this hedge trimmer, read and observe all warnings, cautions, and instructions on the hedge trimmer and in this Owner's Manual.

**NOTE:** The following safety information is not meant to cover all possible conditions and situations that may occur. Read the entire Owner's Manual for safety and operating instructions. Failure to follow instructions and safety information could result in serious injury or death.

This safety alert symbol is used to identify safety information about hazards that can result in personal injury.



A signal word (DANGER, WARNING, or CAUTION) is used with the alert symbol to indicate the likelihood and the potential severity of injury. In addition, a hazard symbol may be used to represent the type of hazard.

**DANGER** Indicates a hazard, which, if not avoided, will result in death or serious injury.

**WARNING** Indicates a hazard, which, if not avoided, could result in death or serious injury.

**CAUTION** Indicates a hazard, which, if not avoided, might result in minor or moderate injury.

**CAUTION** Without the alert symbol, indicates a situation that could result in damage.

## GENERAL SAFETY RULES

Safety is a combination of common sense, staying alert, and knowing how your hedge trimmer works.

**SAVE THESE SAFETY INSTRUCTIONS.**



**WARNING:** Do not operate this unit until you read this instruction manual for safety, operation and maintenance instructions. Failure to follow all instructions listed below may result in electric shock, fire, and/or serious personal injury.

### WORK AREA SAFETY

- Keep work area clean and well lit. Cluttered or dark areas invite accidents.
- Do not operate power tools in explosive atmospheres, such as in the presence of flammable liquids, gases or dust. Power tools create sparks which may ignite the dust or fumes.
- Keep children and bystanders away . All visitors and pets should be kept a safe distance away from the work area.
- Do not operate power tools in explosive atmospheres, such as in the presence of flammable liquids, gases, or dust. Power tools create sparks which may ignite the dust or fumes.
- Do not allow children or untrained individuals to use this unit.
- Don't expose power tools to rain or wet conditions. Water entering a power tool will increase the risk of electric shock.



**WARNING:** Clear the area to be cut before each use. Remove all objects such as cords, lights, wire, or loose string which can become entangled in the cutting blade and create a risk of serious personal injury.

- Before starting the hedge trimmer, hold the unit with both hands with the cutting blades directed away from you. Always use the hedge trimmer properly.
- Do not force the hedge trimmer through heavy shrubbery. This can cause the blades to bind and slow down. If the blades slow down, reduce the pace.
- Do not try to cut stems or twigs that are larger than 3/4 in. thick, or those obviously too large to feed into the cutting blade. Use a non-powered hand saw or pruning saw to trim large stems.
- If blades do become jammed, stop the motor, allow the blades to stop and remove the battery pack before attempting to remove the obstruction.
- If desired, you can use a string to help cut your hedge level. Decide how high you want the hedge. Then, stretch a piece of string along the hedge at this height. Trim the hedge just above this guide line of string. Trim the side of a hedge so that it will be slightly narrower at the top. More of the hedge will be exposed when shaped this way, and it will be more uniform.
- Always hold hedge trimmer with both hands when operating. Use a firm grip on the handles. The unit is used for cutting in either direction in a slow, sweeping action from side to side.
- Wear gloves when trimming thorny or prickly growth.
- When trimming new growth, use a wide sweeping action, so that the stems are fed directly into the cutting blade. Older growth will have thicker stems and will be trimmed easiest by using a sawing movement.

The handle can be rotated 45° or 90° to the left or to the right.

To rotate handle:

- Remove the battery pack.
- Press on the rotating handle button.
- Turn handle to the right or to the left.
- Release rotating handle button.
- Keep turning handle until it locks into place in one of the 45° or 90° positions.

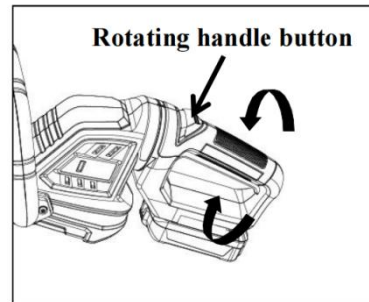

**Note:** The trimmer will only operate at one of these locked positions. The handle is locked when the rotating handle button is securely in place and the handle will no longer move to either side.

### HOLDING THE HEDGE TRIMMER

The unit has both a front and rear handle. With the blade directed away from you, hold the unit by both handles.



**WARNING:** Always keep both hands on the hedge trimmer handles. Never hold shrubs with one hand and operate the hedge trimmer with the other. Improper operation of the hedge trimmer may result in serious injury.

### CUTTING TIPS



**WARNING:** Never cut near electric cords or lines. If blade jams on any electrical cord or line, DO NOT TOUCH THE BLADE! IT CAN BECOME ELECTRICALLY LIVE AND VERY DANGEROUS. Continue to hold the hedge trimmer by the insulated rear handle or lay it down and away from you in a safe manner. Disconnect the electrical service to the damaged line or cord before attempting to free the blade from the line or cord. Contact with the blade, other conductive parts of the hedge trimmer, or live electric cords or lines will result in death by electrocution or serious injury.

- Do not handle plug or tool with wet hands.
- Never allow children to operate the equipment. Never allow adults to operate the equipment without proper instruction.
- Always wear safety glasses with side shields. Everyday glasses have only impact resistant lenses. They are NOT safety glasses. Following this rule will reduce the risk of eye injury. Use face mask if operation is dusty.
- Wear eye protection when operating this product. Secure long hair above shoulder level to prevent entanglement in moving parts.
- Do not expose to rain, store indoors.
- Do not operate in poor lighting.
- Keep all parts of your body away from any moving part.
- Keep hair, loose clothing, fingers and all body parts away from openings and moving parts.
- Wear heavy long pants, boots, and gloves. Avoid loose garments and jewelry that could get caught in moving parts of the machine or its motor.
- Do not force tool. Use the correct tool for your application. The correct tool will do the job better and safer at the rate for which it is designed.
- Do not operate the equipment while barefoot or when wearing sandals or similar lightweight footwear. Wear protective footwear that will protect your feet and improve your footing on slippery surfaces.
- Secure long hair so it is above shoulder level to prevent entanglement in any moving parts.
- Keep firm footing and balance. Do not overreach. Overreaching can result in loss of balance.
- Do not allow to be used as a toy. Close attention is necessary when used by or near children.
- Do not use tool if switch does not turn it on or off. Any tool that cannot be controlled with the switch is dangerous and must be repaired.
- Keep all bystanders, children, and pets at least 50 ft. away.
- Do not operate this unit when you are tired, ill, or under the influence of alcohol, drugs, or medication.
- Keep all parts of your body away from any moving parts and all hot surfaces of the unit.

- Check the work area before each use. Remove all objects such as rocks, broken glass, nails, wire, or string which can be thrown or become entangled in the machine.
- Use only identical manufacturer's replacement parts and accessories. Use of any other parts may create a hazard or cause product damage.
- Do not charge battery tool in rain, or damp or wet location. Following this rule will reduce the risk of electric shock.
- For household use only.
- Battery tools do not have to be plugged into an electrical outlet; therefore, they are always in operating condition. Be aware of possible hazards when not using your battery tool or when changing accessories. Following this rule will reduce the risk of electric shock, fire, or serious personal injury.
- Remove or disconnect battery before servicing, cleaning or removing material from the gardening appliance.
- Use only ZEGJAW battery (Model#ZJ8M125)
- Store idle appliances - When not in use, string trimmer should be stored indoors in a dry, locked place out of the reach of children.
- Do not dispose of the batteries in a fire. The cell may explode. Check with local codes for possible special disposal instructions.
- Do not open or mutilate the batteries. Released electrolyte is corrosive and may cause damage to the eyes or skin. It may be toxic if swallowed.
- Do not place battery tools or their batteries near fire or heat. This will reduce the risk of explosion and possibly injury.
- Batteries can explode in the presence of a source of ignition, such as a pilot light. To reduce the risk of serious personal injury, never use any cordless product in the presence of open flame. An exploded battery can propel debris and chemicals. If exposed, flush with water immediately.
- Do not crush, drop or damage battery pack. Do not use a battery pack or charger that has been dropped or received a sharp blow. A damaged battery is subject to explosion. Properly dispose of a dropped or damaged battery immediately.
- Exercise care in handling batteries in order not to short the battery with conducting materials such as rings, bracelets, and keys. The battery or conductor may overheat and cause burns. Do not open or mutilate the batteries. Released

The charge time dependent on a number of factors, including battery condition, ambient temperature, etc., and may therefore vary from the times specified.

The battery heats up during operation in the power tool. If a hot battery is inserted in the charger, it may be necessary to cool it down before charging. The charging process begins only after the battery has cooled down. The time required for cooling may prolong the charge time.

The battery and charger heat up during the charging process.

#### **END OF CHARGE**

- The green light turns up when the charger is fully charged.
- Remove the fully charged battery from the charger.

## **OPERATING INSTRUCTIONS**



**WARNING:** Read and thoroughly understand all instructions and safety information before operating this hedge trimmer. Failure to do so may cause serious injury or death. Do not allow anyone to operate this hedge trimmer who has not read this manual. A hedge trimmer can be dangerous if assembled or used improperly. Do not operate this hedge trimmer if you have doubts or questions concerning safe operation.

#### **STARTING/STOPPING THE HEDGE TRIMMER**

- Remove the scabbard.
- To prevent the tool accidental starting, the hedge trimmer is designed with a two hand safety switches.
- To turn the hedge trimmer on both the rear handle trigger switch and front handle lock-off switch are required to be activated to start the hedge trimmer.
- To turn the hedge trimmer off, release either the rear handle trigger switch or front handle lock-off switch.

#### **ROTATING HANDLE**

connect the battery, slide the battery pack fully forward. Until the latch locks into place.

### To remove the battery pack

Press the battery release button, Slide the battery pack backward, and then pull or lift the battery out of the tool.



### WARNING:

Follow these instructions in order to avoid injury and to reduce the risk of electric shock or fire:

- Replace the battery pack or the charger immediately if the battery case or charger cord is damaged.
- Verify that the battery pack is removed before inspecting, adjusting, or performing maintenance on any part of the power tool.
- Read, understand, and follow the instructions.

### CONNECTING CHARGER TO POWER SUPPLY

Power supply(mains) voltage and operating voltage must be the same.

- Insert the plug in the wall outlet.
- A self test is performed after the charger is connected to the power supply. During this process, the green light(1) on the charger lights up.

### CHARGING THE BATTERY

A factory-new battery is not fully charged.

Recommendation: Fully charge the battery before using it for the first time.

- Insert Connect the charger to the power supply - mains voltage and operation voltage of the charger must be the same - see “Connecting Charger to Power Supply”.

Operate the charger only in enclosed and dry rooms at ambient temperatures between +5°C to +40°C(+40 °F to 104°F)

Only charge dry batteries. Allow a damp battery to dry before charging.

- Push the battery into the charger until noticeable resistance is felt - then push it as far as stop.
- Charging begins as soon as the red light on the charger turns up.

electrolyte is corrosive and may cause damage to the eyes or skin. It may be toxic if swallowed.

- For best results, your battery tool should be charged in a location where the temperature is more than 45°F but less than 104°F. To reduce the risk of serious personal injury, do not store outside or in vehicles.
- Under extreme usage or temperature conditions, battery leakage may occur. If liquid comes in contact with your skin, wash immediately with soap and water, then neutralize with lemon juice or vinegar. If liquid gets into your eyes, flush them with clean water for at least 10 minutes, then seek immediate medical attention. Following this rule will reduce the risk of serious personal injury.
- If the power supply cord is damaged, it must be replaced only by the manufacturer or by an authorized service center to avoid risk.
- Do not point the string trimmer in the direction of people or pets.
- When not in use, string trimmer should be stored indoors in a dry, locked up place- out of the reach of children.
- Maintain tool with care. Keep the string trimmer clean for best and safest performance. Follow instructions for proper maintenance. Do not attempt to clear clogs from tool without first removing the battery.
- To reduce the risk of electrical shock, do not expose to rain, do not use on wet surfaces. Store indoors.
- Save these instructions. Refer to them frequently and use them to instruct others who may use this battery tool. If you loan someone this battery tool, loan them these instructions also.

### CHILD SAFETY

Tragic accidents can occur if the operator is not aware of the presence of children.

- Keep children out of the working area and under the watchful care of a responsible adult.
- Do not allow children under the age of 14 to operate this trimmer. Children who are 14 years of age and older must read and understand the operating instructions and safety rules in this manual, and must be trained and supervised by a parent.
- Stay alert, and turn the trimmer off if a child or any other person enters the working area.
- Look behind and down for small children before and while cutting backwards.

➤ Use extreme care when approaching blind corners, doorways, shrubs, trees, or other objects that may obscure your view of a child who may run into the path of the trimmer.

## PERSONAL SAFETY

- All visitors, children and pets should stay at a safe distance from the work area. Keep bystanders away.
- Stay alert. Watch what you are doing. Use common sense. Do not operate hedge trimmer when you are tired or under the influence of drugs, alcohol or medications.
- Use right appliance. Do not use an appliance for any job except that for which it is intended.
- Don't wear loose clothing or jewelry. Wear protective hair covering to contain long hair. They can be caught in moving parts. Use of rubber gloves and substantial footwear is recommended when working outdoors.
- Wear safety glasses with side shields or goggles that are marked to comply with ANSI Z87.1 standard when operating this product. Use face or dust mask if environment is dusty.
- Do not operate the equipment while barefoot or when wearing sandals or similar lightweight footwear. Wear protective footwear that will protect your feet and improve your footing on slippery surfaces.
- Keep all parts of your body away from any moving part.
- Do not overreach. Keep firm footing and balance. Overreaching can result in loss of balance.
- Prevent unintentional starting. Ensure the switch is in the off-position before connecting to power source and/or battery pack, picking up or carrying the tool. Carrying power tools with your finger on the switch or energizing power tools that have the switch on invites accidents.
- Do not use on a ladder or unstable support. Stable footing on a solid surface enables better control of the power tool in unexpected situations.
- Ground Fault Circuit Interrupter(GFCI) protection should be provided on the circuit(s) or outlet(s) to be used for the hedge trimmer. Receptacles are available having built-in GFCI protection and may be used.

Do not use this product if any parts on the packing list are already assembled to your product when you unpack it. Parts on this list are not assembled to the product by the manufacturer and require customer installation. Use of a product that may have been improperly assembled could result in serious personal injury.



### WARNING:

If any parts are damaged or missing do not operate this product until the parts are replaced. Use of this product with damaged or missing parts could result in serious personal injury.



### WARNING:

Do not attempt to modify this product or create accessories not recommended for use with this product. Any such alteration or modification is misuse and could result in a hazardous condition leading to possible serious personal injury.



### WARNING:

Do not connect to power supply until assembly is complete. Failure to comply could result in accidental starting and possible serious personal injury.



### WARNING:

Before assembly, make sure that the tool is switched off and the battery has been removed.

## CONNECTING AND REMOVING BATTERY

### IMPORTANT!

The battery pack is not charged when it is purchased. Before using the power tool for the first time, place the battery pack in the battery charger and charge. Make sure to read all safety precautions, and follow the instructions in the battery charger section.

### To install the battery pack

To install the battery pack into the bottom of the handle, align the rails of the battery pack with the rails in the handle and push the battery into the handle. To

## KNOWING YOUR HEDGE TRIMMER

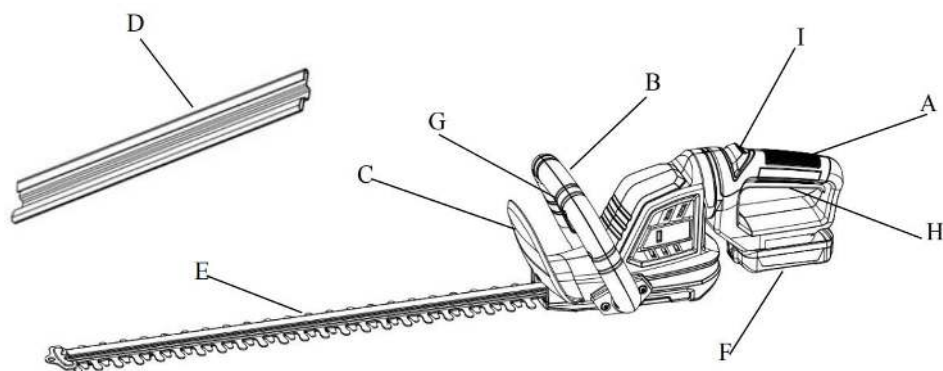

- |                          |                  |
|--------------------------|------------------|
| A Rear Handle            | B Front Handle   |
| C Safety Guard           | D Scabbard       |
| E Blade                  | F Battery        |
| G Lock-off Button        | H Trigger Switch |
| I Rotating handle button |                  |

### Unpacking

Unpack the hedge trimmer and all its parts, and compare against the list below. Do not discard the carton or any packaging materials. Please E-mail us at [support@dgiproduct.com](mailto:support@dgiproduct.com) if any parts are damaged or missing.

Including: Hedge Trimmer / 20V Battery and Charger / Scabbard / User manual

### Scabbard

The scabbard keeps the operator from coming in contact with the sharp blades when the tool is not in use. It also helps keep the blades from being nicked or damaged when the tool is in storage.

## ASSEMBLY INSTRUCTIONS



**WARNING:**



**WARNING:** Some dust created by this product contains chemicals known to the State of California to cause cancer, birth defects or other reproductive harm.

Some examples of these chemicals are:

- compounds in fertilizers
- compounds in insecticides, herbicides and pesticides
- arsenic and chromium from chemically treated lumber

Your risk from exposure to these chemicals varies depending on how often you do this type of work. To reduce your exposure to these chemicals, wear approved safety equipment such as dust masks that are specially designed to filter out microscopic particles.

### POWER TOOL USE AND CARE

- Know this tool. Read manual carefully, learn its applications and limitations, as well as the specific potential hazards related to this tool.
- Check for misalignment or binding of moving parts, breakage of parts, and any other condition that may affect the power tools operation. If damaged, have the power tool serviced before using. Many accidents are caused by poorly maintained tools.
- Do not force power tool. Use the correct power tool for your application. The correct power tool will do the job better and safer at the rate for which it is designed.
- Disconnect the plug from the power source and/or the battery pack from the power tool before making any adjustments, changing accessories, or storing power tools. Such preventive safety measures reduce the risk of starting the power tool accidentally.
- Store idle power tools out of reach of children and other untrained persons. Power tools are dangerous in the hands of untrained users.
- Check operation of the tool before use. Do not use the tool if the work piece contact mechanism is not working correctly as accidental driving of a fastener may occur.
- Do not use the power tool if switch does not turn it on or off. Any power tool that cannot be controlled with the switch is dangerous and must be repaired.

- Keep cutting tools sharp and clean. Properly maintained cutting tools with sharp cutting edges are less likely to bind and are easier to control.
- Do not operate the tool if it does not contain a legible warning label.
- Use the power tool, accessories and tool bits etc. in accordance with these instructions, taking into account the working conditions and the work to be performed. Use of the power tool for operations different from those intended could result in a hazardous situation.
- Save these instructions. Refer to them frequently and use them to instruct others who may use this tool. If you lend this tool to someone else, also lend them these instructions.

### BATTERY TOOL USE AND CARE











**WARNING:** USE ONLY ZEGJAW APPROVED REPLACEMENT BATTERIES, OTHER BATTERIES MAY CAUSE INJURY OR DAMAGE TO THE MOWER. Use with ZEGJAW 20V battery.

#### Battery safety rules

- Battery tools do not have to be plugged into an electrical outlet; therefore, they are always in operating condition. Be aware of possible hazards when not using your battery tool or when changing accessories. Following this rule will reduce the risk of electric shock, fire, or serious personal injury.
- Do not place battery tools or their batteries near fire or heat. This will reduce the risk of explosion and injury.
- Do not crush, drop or damage battery pack. Do not use a battery pack or charger that has been dropped or received a sharp blow. A damaged battery is subject to explosion. Properly dispose of a dropped or damaged battery immediately.
- Batteries can explode in the presence of a source of ignition, such as a pilot light. To reduce the risk of serious personal injury, never use any cordless product in the presence of open flame. An exploded battery can propel debris and chemicals. If exposed, flush with water immediately. Do not charge battery tool in a damp or wet location. Following this rule will reduce the risk of electric shock.

## SYMBOLS

Some of the following symbols may be used on this product. Please study them and learn their meaning. Proper interpretation of these symbols will allow you to operate the product better and safer.

SYMBOL	NAME	DESIGNATION/EXPLANATION
V	Volts	Voltage
A	Amperes	Current
Hz	Hertz	Frequency (cycles per second)
W	Watts	Power
min	Minutes	Time
	Safety Alert	Precautions that involve your safety.
	Read the user's manual	To reduce the risk of injury, user must read and understand user's manual before using this product.
	Eye protection	Wear eye protection when operating this equipment.
	Wet conditions alert	Do not expose to rain or use in damp locations.
	No Hands Symbol	Failure to keep your hands away from the blade will result in serious personal injury.
	Gloves	Wear non-slip, heavy-duty protective gloves when handling the blades.
	Ricochet	Thrown objects can ricochet and result in personal injury or property damage.
	Keep Bystanders away	Keep all bystanders at least 50 ft. away.
	Electric shock alert	Beware of electric shock hazard.

- Store the unit inside in a dry place, either locked up or up high to prevent unauthorized use or damage. Keep out of the reach of children or untrained individuals.
- Replace blade cover when unit is not in use.
- Never douse or squirt the unit with water or any other liquid. Keep handles dry, clean, and free from debris. Clean after each use; see storage instructions.
- Secure the unit while transporting.
- Battery operated units do not have to be plugged into an electrical outlet; therefore, they are always in operating condition. Be aware of possible hazards even when unit is not operating.
- Remove the battery pack before making any adjustments, cleaning, storing, or removing material from the unit, or when not in use.
- Never use water or any liquids to clean or rinse off your product and do not expose the product to rain or wet conditions. Store indoors in a dry area. Corrosive liquids, water, and chemicals can enter the product's electronic components and/or battery compartment and damage electronic components and/or the battery pack, which can result in a short circuit, increased risk of fire, and serious personal injury. Remove any buildup of dirt and debris by wiping the product clean with a dry cloth occasionally.
- When transporting or storing the hedge trimmer always fit the cutting device cover.
- Save these instructions. Refer to them frequently and use them to instruct others who may use this tool. If you loan someone this tool, loan them these instructions also.

- For best results, your battery tool should be charged in a location where the temperature is more than 45°F but less than 104°F. To reduce the risk of serious personal injury, do not store outside or in vehicles.
- Under extreme usage or temperature conditions, battery leakage may occur. If liquid comes in contact with your skin, wash immediately with soap and water. If liquid gets into your eyes, flush them with clean water for at least 10 minutes, then seek immediate medical attention. Following this rule will reduce the risk of serious personal injury.
- When battery pack is not in use, keep it away from other metal objects like: paper clips, coins, keys, nails, screws, or other small metal objects that can make a connection from one terminal to another. Shorting the battery terminals together may cause sparks, burns, or a fire.
- Always remove battery pack from your tool when you are assembling parts, making adjustments, cleaning, or when not in use. Removing battery pack will prevent accidental starting that could cause serious personal injury.
- Always remove battery pack before storing the device. When battery becomes fully charged, unplug the charger from the power supply and remove the battery pack from the charger.
- Always wear eye protection with side shields marked to comply with ANSI Z87.1, along with hearing protection. Failure to do so could result in objects being thrown into your eyes and other possible serious injuries.
- Keep battery pack dry, clean, and free from oil and grease. Always use a clean cloth when cleaning. Never use brake fluids, gasoline, petroleum-based products, or any solvents to clean battery pack.
- Do not open or mutilate the battery. Released electrolyte is corrosive and may cause damage to the eyes or skin. It may be toxic if swallowed.

### **Proper care for battery**

#### Off-season storage

To obtain the longest possible battery life, we suggest the following:

- Remove the battery pack from the charger once it is fully charged and ready for use. For battery pack storage longer than 30 days:
- Store the battery pack where the temperature is below 80°F and away from moisture.

- Store battery packs in a fully charged condition.
- Every two months of storage, charge the pack as normal.

### Charger safety rules

- Charge the battery in a dry area that is protected from the weather. Do not expose the hedge trimmer or the charger to rain. Do not charge the battery in a wet location. Operate the battery charger in temperatures between 45° and 104°F. In order to reduce the risk of electric shock, use only the charger that is provided by the manufacturer to charge the battery.
- DO NOT ABUSE THE CHARGE CORD. Never carry the charger by the cord. Do not disconnect the charger from the outlet by pulling the charger cord.
- Do not use a damaged charger. Replace the charger cords or the charger immediately.
- Keep the hedge trimmer and the charger away from water, heat sources (radiators, heaters, stoves, etc.), flames, and chemicals.
- Make sure the battery pack is secured in the charger before beginning operation.
- The battery pack will become slightly warm to the touch while charging. This is normal and does not indicate a problem.
- Do not place the charger and battery pack in an area of extreme heat or cold. They will work best at normal room temperature.
- When batteries become fully charged, unplug the charger from the power supply and remove the battery pack.



**WARNING:** When transporting or servicing unit, always remove the battery.

### SERVICE

- Tool service must be performed only by qualified repair personnel. Service or maintenance performed by unqualified personnel could result in a risk of injury.
- When servicing a tool, use only identical replacement parts. Follow instructions in the Maintenance section of this manual. Use of unauthorized parts or failure to follow Maintenance Instructions may create a risk of electric shock or injury.

## SPECIFIC SAFETY RULES FOR HEDGE TRIMMER

- Use both hands when operating the hedge trimmer. Using one hand could cause loss of control and result in serious personal injury.
- Keep all parts of the body away from the cutter blade. Do not remove cut material or hold material to be cut when blades are moving. Make sure the switch is off when clearing jammed material. Blades coast after turn off. A moment of inattention while operating the hedge trimmer may result in serious personal injury.
- Only use with handle and guard properly assembled to hedge trimmer. The use of the hedge trimmer without the proper guard or handle provided may result in serious personal injury.
- Carry the hedge trimmer by the handle with the cutter blade stopped. Proper handling of the hedge trimmer will reduce possible personal injury from the cutter blades.
- Hold the power tool by insulated gripping surfaces only, because the cutter blade may contact hidden wiring. Cutter blades contacting a “live” wire may make exposed metal parts of the power tool “live” and could give the operator an electric shock.
- Always wear eye protection with side shields marked to comply with ANSI Z87.1. Following this rule will reduce the risk of serious personal injury.
- Clear the area to be cut before each use. Remove all objects such as cords, lights, wire, or loose string which can become entangled in the cutting blade and create a risk of serious personal injury.
- Before starting the hedge trimmer, make sure the blade is not in contact with any object.
- Stop the unit, remove the battery pack, and make sure the blade has stopped before setting the unit down.
- Never cut any material with a diameter larger than 3/4 in.
- Always stop the motor when cutting is delayed or when walking from one cutting location to another.
- Keep unit clean of clippings and other materials. They may become lodged in the cutting blades.
- If hedge trimmer is equipped with a debris remover, do not use the debris remover as a gripping surface.