

VEVOR

Affordable. Reliable. Home Improvement.

DOME TUNNEL GREENHOUSE

Model: 15*7*7 ft (Green)

15*7*7 ft (White)

VEVOR[®]

TOUGH TOOLS, HALF PRICE

DOME TUNNEL GREENHOUSE

Model: 15*7*7 ft (Green)
15*7*7 ft (White)



This is the original instruction, please read all manual instructions carefully before operating. VEVOR reserves a clear interpretation of our user manual. The appearance of the product shall be subject to the product you received. Please forgive us that we won't inform you again if there are any technology or software updates on our product.

GENERAL SAFETY RULES

WARNING:

1. Please read this manual carefully before using the product.
2. Flammable: Keep away from open flame. This product will ignite and burn if brought into contact with an open flame.
3. Keep away from sharp points, blades and other items, so as not to scratch the product.
4. This product is not a toy, dome tunnel greenhouse cannot be used as toys for children to play with.
5. Keep away from rain, water, hail, etc. to avoid damaging the documents in your bag .

SAVE THESE INSTRUCTION

SPECIFICATIONS

Model	15*7*7 ft (Green)
Product Size	4.5×2×2m
Color	Green

Model	15*7*7 ft (White)
Product Size	4.5×2×2m
Color	White

Please carefully follow assembly instruction. Suggested 2-4 person to construction.

COMPONENTS

Important suggestion

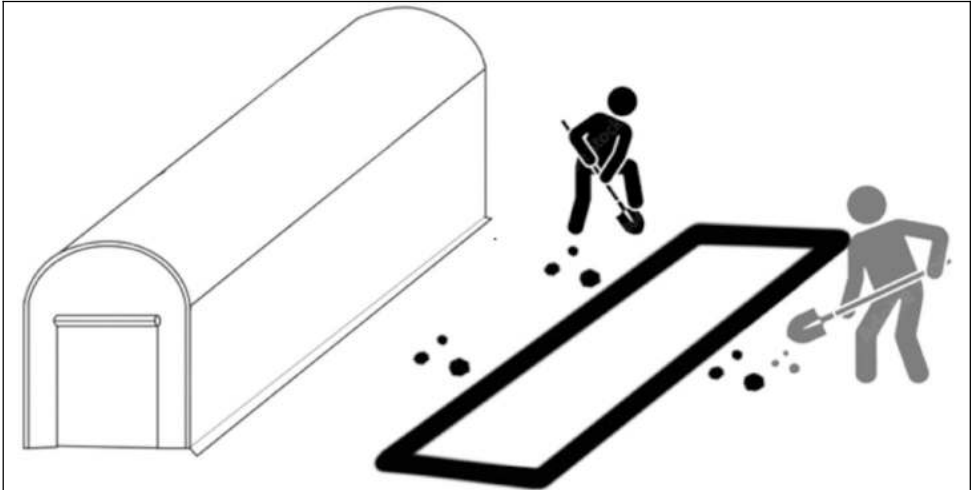



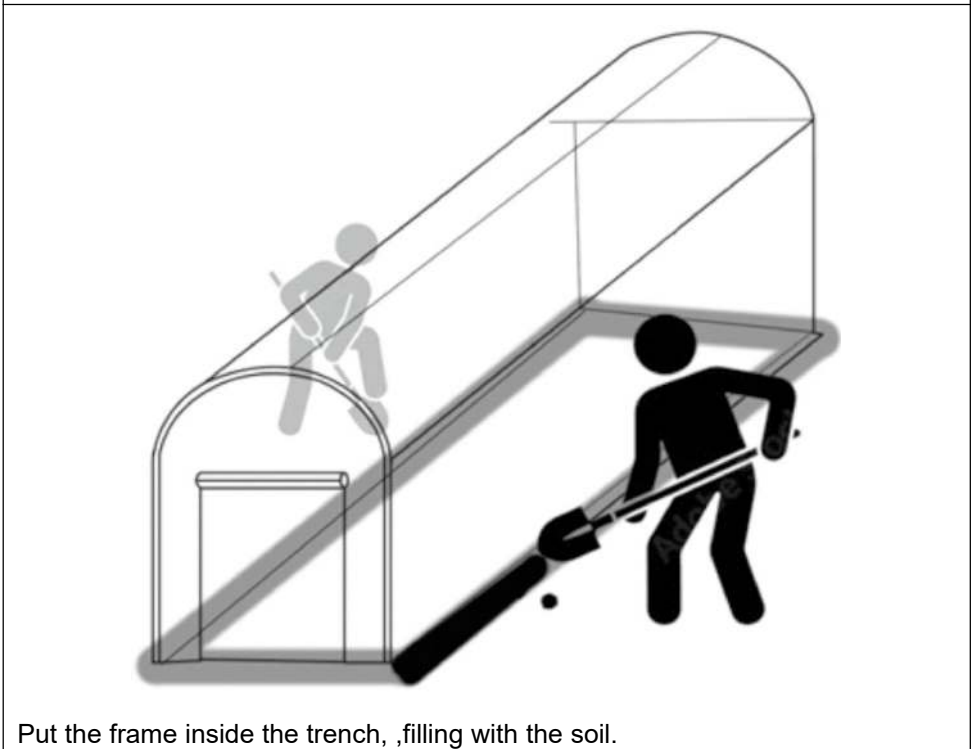



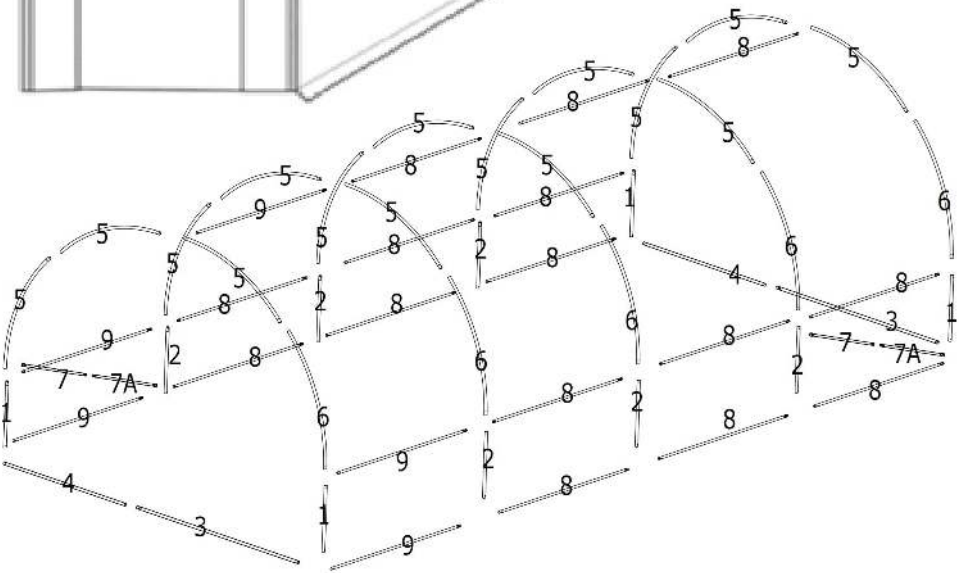
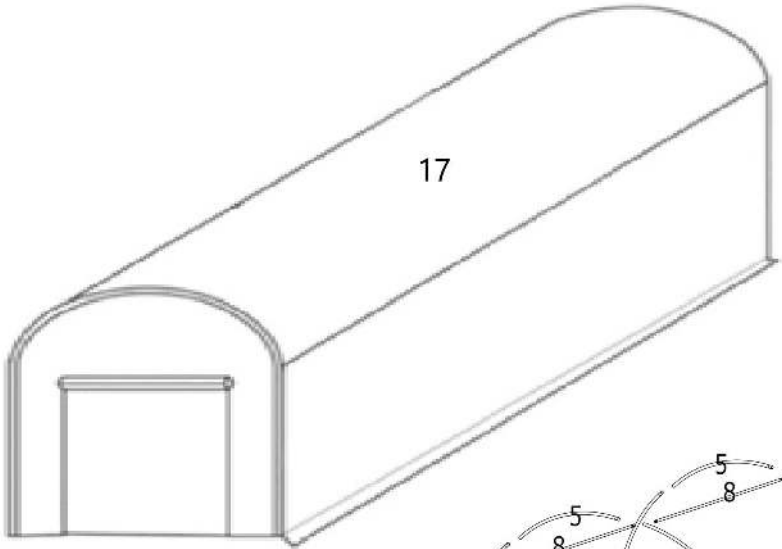





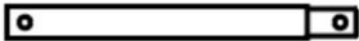
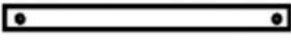

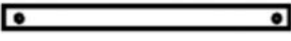

For maximum stability of your polytunnel, we recommend digging a 20cm width trench around the base of the polytunnel and back.









Put the frame inside the trench, filling with the soil.

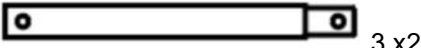
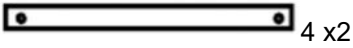
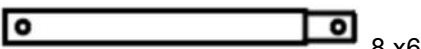

Product List

1	 <p>Straight Rod x4</p>	2	 <p>Straight Rod x6</p>
3	 <p>Straight Rod x2</p>	4	 <p>Straight Rod x2</p>
5	 <p>Arced Rod x15</p>	6	 <p>Arced Rod x5</p>
7	 <p>Straight Rod (7 x2;7A x2)</p>	8	 <p>Straight Rod x15</p>
9	 <p>Straight Rod x5</p>	10	 <p>Bolt x29</p>
11	 <p>Bolt x14</p>	12	 <p>Nut x43</p>
13	 <p>Screwdriver x1</p>	14	 <p>Screwdriver x1</p>
15	 <p>Tent peg x4</p>	16	 <p>String x4</p>
17	 <p>Tarpaulin x1</p>	18	 <p>plastic plug x10</p>

Product Description

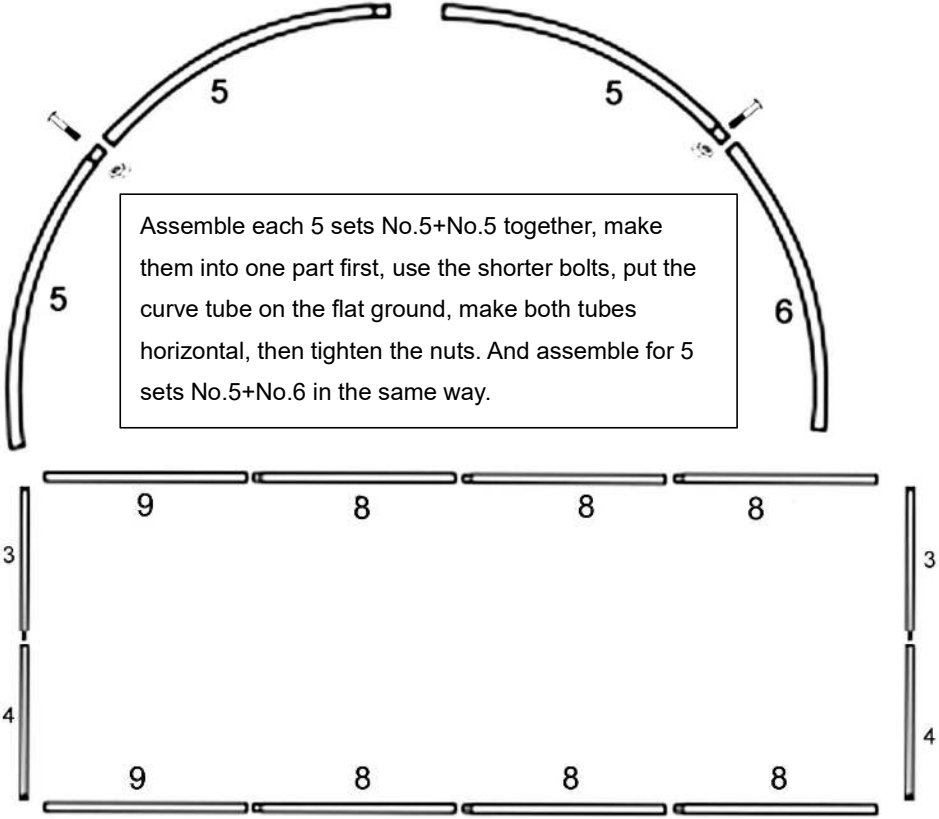
Step 1	
 5 x15	 6 x5
 3 x2	 4 x2
 8 x6	 9 x2
 11 x12	 12 x12
 <div style="border: 1px solid black; padding: 10px; margin: 10px auto; width: 80%; text-align: left;"> <p>Assemble each 5 sets No.5+No.5 together, make them into one part first, use the shorter bolts, put the curve tube on the flat ground, make both tubes horizontal, then tighten the nuts. And assemble for 5 sets No.5+No.6 in the same way.</p> </div>	
<p>Assemble for 2 sets floor tubes No3+ No4 use the shorter bolts, and the horizontal frame No9+No8+No8+No8 together.</p>	

Step 2

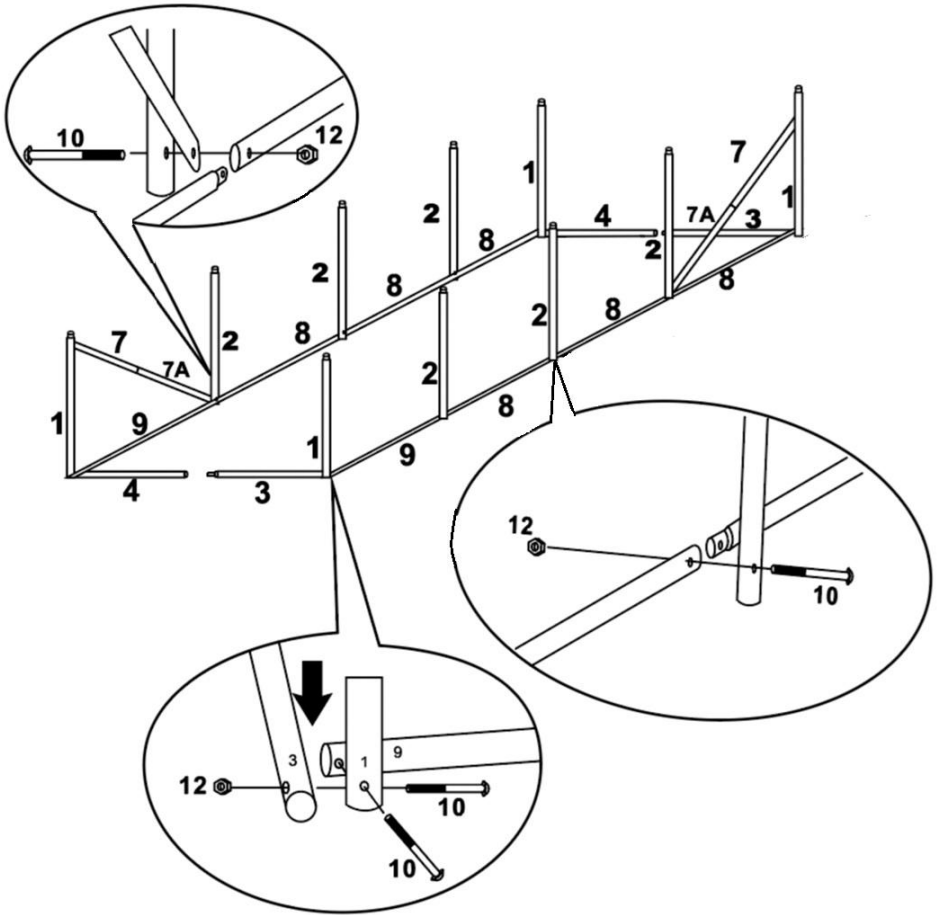
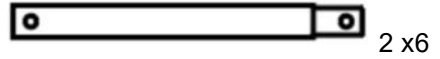
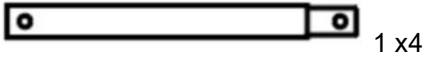

Loosely assemble complete frame, before tightening all bolts in final position.

Step 3

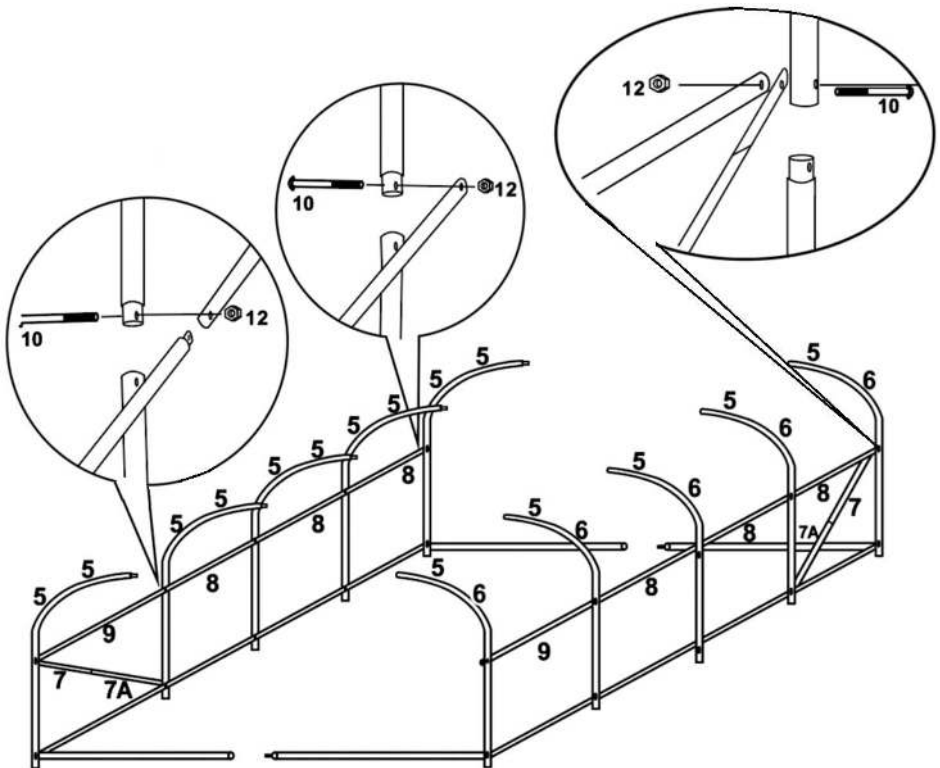
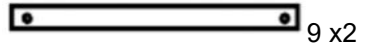
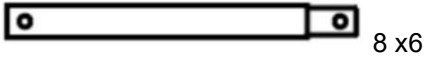

Loosely assemble complete frame, before tightening all bolts in final position.

Step 4

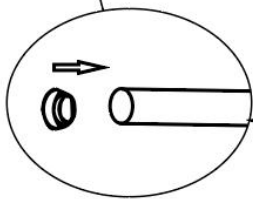
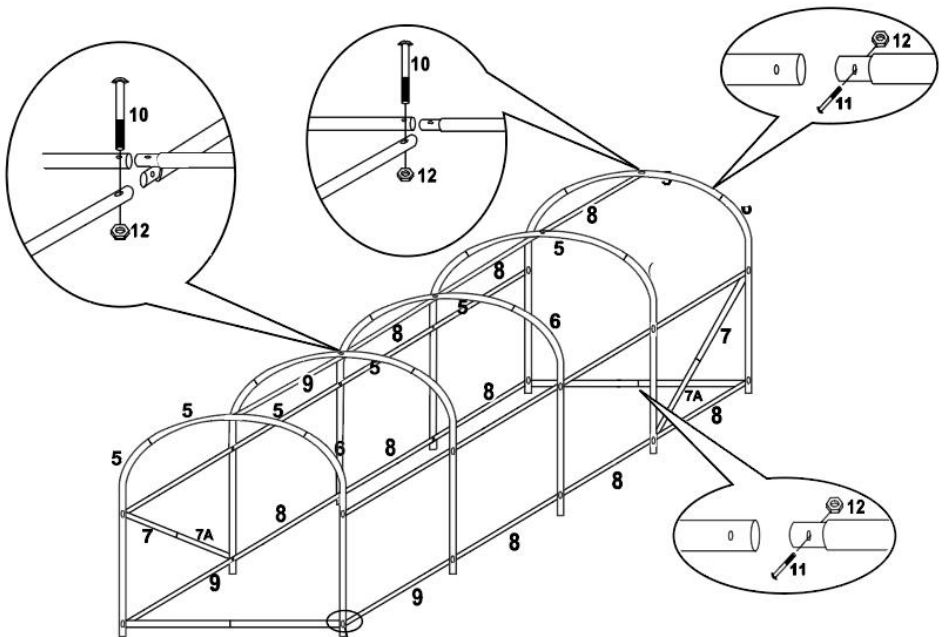
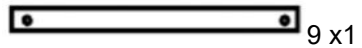
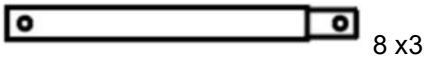

Put all plastic caps No 18 on each ends of the tubes firstly avoid any possible tear damage when covering the roof.

Loosely assemble completed frame before tightening all bolts in final position.

Step 5

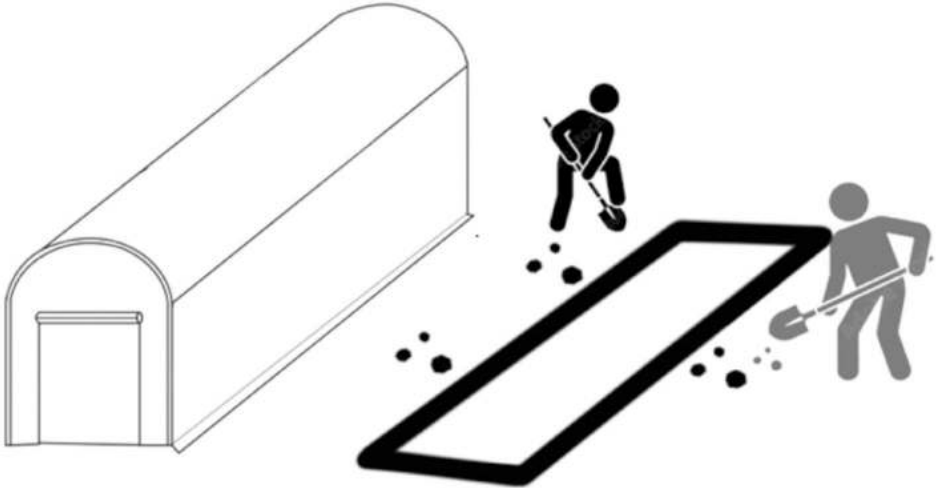

For maximum stability of your polytunnel, we recommend digging a 20cm width trench around the base of the polytunnel and back.



Put the frame inside the trench, filling with the soil.

Step 6



15 x4

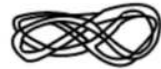

16 x4

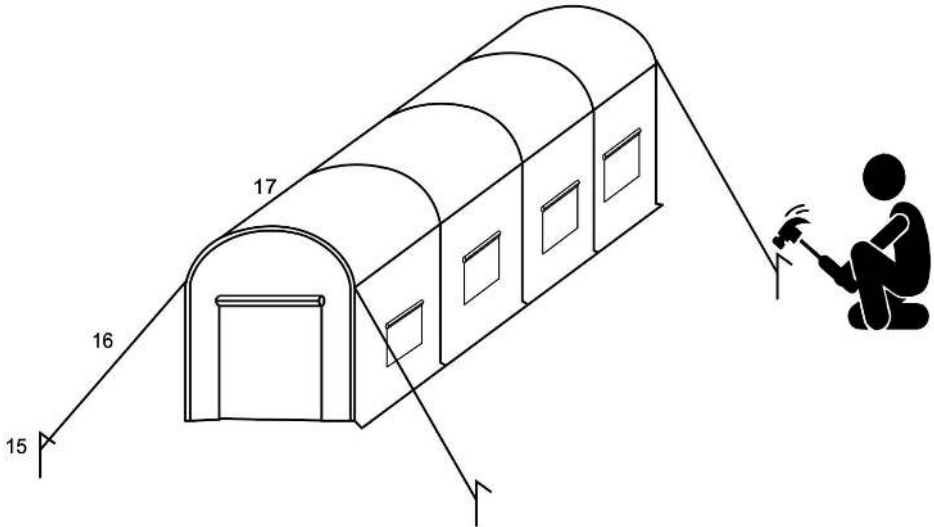

Tied the string in the back of the cover to the frame. Use the ropes and stakes for four corners of the greenhouse, to reinforce the stability of it.

WARNING

Covering the roof carefully, puts all places in the right position. As much as possible as not make the frame structure of the greenhouse out of the shape.

Do not use it in bad weather conditions, such as a rainstorm, hailstone, heavy snow, and heavy wind.

Address: Baoshanqu Shuangchenglu 803long 11hao 1602A-1609shi Shanghai

Manufacturer: Shanghaimuxinmuyeyouxiangongsi

Address: Shuangchenglu 803nong11hao1602A-1609shi, baoshanqu, shanghai 200000 CN.

E-mail: support@vevor.com

Imported to AUS: SIHAO PTY LTD. 1 ROKEVA STREETEASTWOOD NSW 2122 Australia

Imported to USA: Sanven Technology Ltd. Suite 250, 9166 Anaheim Place, Rancho Cucamonga, CA 91730

UK	REP
-----------	------------

YH CONSULTING LIMITED. C/O YH Consulting Limited Office 147, Centurion House, London Road, Staines-upon-Thames, Surrey, TW18 4AX

EC	REP
-----------	------------

E-CrossStu GmbH
Mainzer Landstr.69,
60329 Frankfurt am Main.

