

STAIR CLIMBING CART

MODEL: 2025C

STAIR CLIMBING CART

MODEL:2025C



SAFETY INSTRUCTIONS

WARNING:

1. Please do not put it near flammable materials.
2. It is forbidden to carry people under any condition.
3. Please pay attention to safety when going up and down stairs.
4. Overload is strictly prohibited.
5. Don't move too fast when passing pothole areas.

MODEL AND PARAMETERS

Model	2025C
Maximum Load(Flat Ground)	460lbs
Maximum Load(Climb Stairs)	220lbs
Color	Black
Material	Steel+Rubber+PP

STRUCTURE DIAGRAM AND COMPONENTS

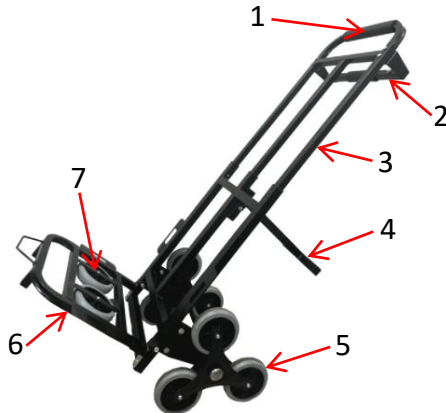

- 1.Handle 1 2.Handle 2 3.Frame 4.Support bar
5.Climbing Wheel 6.Tray 7.Spare wheels

COMPONENTS



A: Cart Frame x1



B: Wheel Frame x1



C: Wheel Sets x2



D: Nuts x4



E: Washer x2



F: Bolts x4



G: A plum lock x2

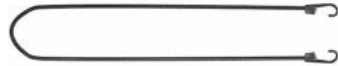

Elastic Binding Rope x2



Installation Tools x2



User manual x1

ASSEMBLY

1. Place the frame(A), and then install the Wheel Frame(B).

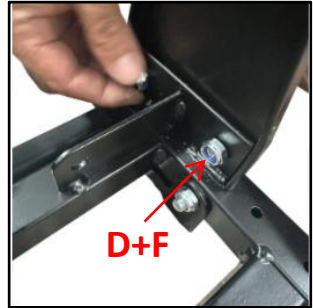

2. Put the Washer (C) on each end.

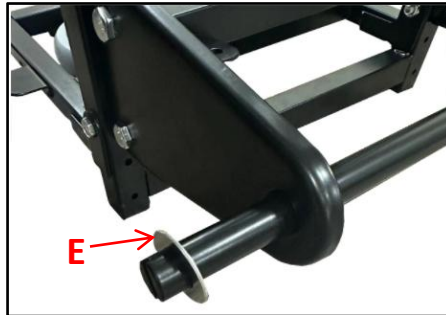

3. Install the Wheel Sets (C).



4. Install the A plum lock (G).(Note: Press into with force.)



MAINTENANCE

1. Avoid prolonged exposure to the sun to avoid aging.
2. Avoid children taking the stair climbing cart to play.

Manufacturer: Shanghaimuxinmuyeyouxiangongsi

Address: Shuangchenglu 803nong11hao1602A-1609shi, baoshanqu, shanghai 200000 CN.

EC REP: E-CrossStu GmbH.

Mainzer Landstr.69, 60329 Frankfurt am Main.

UK REP: YH CONSULTING LIMITED.

C/O YH Consulting Limited Office 147, Centurion House, London Road, Staines-upon-Thames, Surrey, TW18 4AX

Imported to AUS: SIHAO PTY LTD.

1 ROKEVA STREETEASTWOOD NSW 2122 Australia

Imported to USA: Sanven Technology Ltd.

Suite 250, 9166 Anaheim Place, Rancho Cucamonga, CA 91730

CHARIOT MONTE-ESCALIER

MODÈLE : 2025C

CHARIOT MONTE-ESCALIER

MODÈLE : 2025C



CONSIGNES DE SÉCURITÉ

AVERTISSEMENT:

1. Veuillez ne pas le placer à proximité de matériaux inflammables.
2. Il est interdit de transporter des personnes sous quelque condition que ce soit.
3. Veuillez faire attention à la sécurité lorsque vous montez et descendez les escaliers.
4. La surcharge est strictement interdite.
5. Ne vous déplacez pas trop vite lorsque vous passez près de nids-de-poule.

MODÈLE ET PARAMÈTRES











Modèle	2025C
Charge maximale (sol plat)	460 livres
Charge maximale (monter les escaliers)	220 livres
Couleur	Noir
Matériel	Acier+Caoutchouc+PP

SCHÉMA DE STRUCTURE ET COMPOSANTS



- 1.Poignée 1 2.Poignée 2 3.Cadre 4.Barre de support
5.Roue d'escalade 6.Plateau 7.Roues de secours

COMPOSANTS

 <p>A : Cadre de chariot x1</p>	 <p>B : Cadre de roue x1</p>
 <p>C : Ensemble de roues x2</p>	 <p>D : Noix x4</p>
 <p>E : Rondelle x2</p>	 <p>F : boulons x4</p>
 <p>G : Une serrure prune x2</p>	 <p>Corde élastique de fixation x2</p>
 <p>Outils d'installation x2</p>	 <p>Manuel d'utilisation x1</p>

ASSEMBLÉE

1. Placez le cadre (A), puis installez le cadre de roue (B).

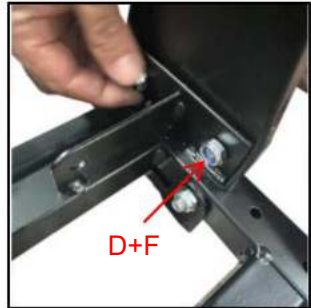

2. Placez la rondelle (C) à chaque extrémité.



3. Installez les jeux de roues (C).



4. Installez le verrou à prune A (G). (Remarque : appuyez avec force.)



ENTRETIEN

1. Évitez l'exposition prolongée au soleil pour éviter le vieillissement.
2. Évitez que les enfants prennent le chariot monte-escalier pour jouer.

Fabricant : Shanghaimuxinmuyeyouxiangongsi

Adresse : Shuangchenglu 803nong11hao1602A-1609shi, baoshanqu, shanghai 200000 CN.

CE REP : E-CrossStu GmbH.

Mainzer Landstr.69, 60329 Francfort-sur-le-Main.

REPRÉSENTANT AU ROYAUME-UNI : YH CONSULTING LIMITED.

C/O YH Consulting Limited Bureau 147, Centurion House, London Road, Staines-upon-Thames, Surrey, TW18 4AX

Importé en AUS : SIHAO PTY LTD.

1 ROKEVA STREET EASTWOOD NSW 2122 Australie

Importé aux États-Unis : Sanven Technology Ltd.

Suite 250, 9166 Anaheim Place, Rancho Cucamonga, CA 91730

TREPPENKARRET

MODELL: 2025C

TREPPENKARRET

MODELL:2025C



SICHERHEITSHINWEISE

WARNUNG:

1. Bitte nicht in der Nähe von brennbaren Materialien aufbewahren.
2. Die Beförderung von Personen ist unter allen Umständen verboten.
3. Achten Sie beim Treppensteigen auf die Sicherheit.
4. Überlastung ist strengstens verboten.
5. Fahren Sie nicht zu schnell durch Schlaglöcher.

MODELL UND PARAMETER











Modell	2025C
Maximale Belastung (ebener Boden)	460 Pfund
Maximale Belastung (Treppensteigen)	220 Pfund
Farbe	Schwarz
Material	Stahl+Gummi+PP

STRUKTURDIAGRAMM UND KOMPONENTEN



- 1.Griff 1 2.Griff 2 3.Rahmen 4.Stützstange
5.Kletterrad 6.Tablett 7.Ersatzräder

KOMPONENTEN

 <p>A: Wagenrahmen x1</p>	 <p>B: Radrahmen x1</p>
 <p>C: Radsätze x2</p>	 <p>D: Nüsse x4</p>
 <p>E: Unterlegscheibe x2</p>	 <p>F: Schrauben x4</p>
 <p>G: Ein Pflaumenschloss x2</p>	 <p>Elastisches Bindeseil x2</p>
 <p>Installationswerkzeuge x2</p>	 <p>Benutzerhandbuch x1</p>

MONTAGE

1. Platzieren Sie den Rahmen (A) und installieren Sie dann den Radrahmen (B).

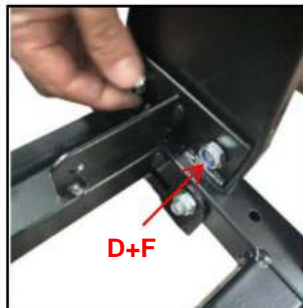

2. Setzen Sie an jedes Ende eine Unterlegscheibe (C).



3. Montieren Sie die Radsätze (C).



4. Installieren Sie das A-Pflanzenschloss (G). (Hinweis: Mit Kraft hineindrücken.)



WARTUNG

1. Vermeiden Sie längere Sonneneinstrahlung, um der Hautalterung vorzubeugen.
2. Vermeiden Sie, dass Kinder mit dem Treppensteigerwagen spielen.

Hersteller: Shanghaimuxinmuyeyouxiangongsi

Adresse: Shuangchenglu 803nong11hao1602A-1609shi, baoshanqu, Shanghai 200000 CN.

EG-Vertreter: E-CrossStu GmbH.

Mainzer Landstr.69, 60329 Frankfurt am Main.

UK-VERTRETER: YH CONSULTING LIMITED.

C/O YH Consulting Limited Office 147, Centurion House, London Road, Staines-upon-Thames, Surrey, TW18 4AX

Nach AUS importiert: SIHAO PTY LTD.

1 ROKEVA STREETEASTWOOD NSW 2122 Australien

In die USA importiert: Sanven Technology Ltd.

Suite 250, 9166 Anaheim Place, Rancho Cucamonga, CA 91730

CARRELLO PER SALIRE LE SCALE

MODELLO: 2025C

CARRELLO PER SALIRE LE SCALE

MODELLO:2025C



ISTRUZIONI DI SICUREZZA

AVVERTIMENTO:

1. Non posizionarlo vicino a materiali infiammabili.
2. È vietato trasportare persone in qualsiasi condizione.
3. Prestare attenzione alla sicurezza quando si salgono e scendono le scale.
4. Il sovraccarico è severamente vietato.
5. Non muoversi troppo velocemente quando si passa in zone con buche.

MODELLO E PARAMETRI

Modello	2025C
Carico massimo (terreno pianeggiante)	460 libbre
Carico massimo (salire le scale)	220 libbre
Colore	Nero
Materiale	Acciaio+Gomma+PP

SCHEMA STRUTTURALE E COMPONENTI



1. Maniglia 1 2. Maniglia 2 3. Telaio 4. Barra di supporto
5. Ruota di arrampicata 6. Vassoio 7. Ruote di scorta

COMPONENTI



A: Telaio del carrello x1



B: Telaio ruota x1



C: Set di ruote x2



D: Noci x4



E: Rondella x2



F: Bulloni x4



G: Un lucchetto a forma di prugna x2



Corda elastica x2



Strumenti di installazione x2



Manuale utente x1

ASSEMBLAGGIO

1. Posizionare il telaio (A), quindi installare il telaio della ruota (B).

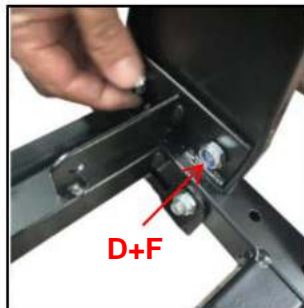

2. Posizionare la rondella (C) su ciascuna estremità.



3. Installare i set di ruote (C).



4. Installare il blocco A (G). (Nota: premere con forza.)



MANUTENZIONE

1. Evitare l'esposizione prolungata al sole per prevenire l'invecchiamento.
2. Evitare che i bambini usino il carrello saliscale per giocare.

Produttore: Shanghai muxinmuyeyouxiangongsi

Indirizzo: Shuangchenglu 803nong11hao1602A-1609shi, baoshanqu, shanghai 200000 CN.

RAPPRESENTANTE CE: E-CrossStu GmbH.

Mainzer Landstr.69, 60329 Francoforte sul Meno.

RAPPRESENTANTE DEL REGNO UNITO: YH CONSULTING LIMITED.

C/O YH Consulting Limited Ufficio 147, Centurion House, London Road, Staines-upon-Thames, Surrey, TW18 4AX

Importato in AUS: SIHAO PTY LTD.

1 ROKEVA STREET EASTWOOD NSW 2122 Australia

Importato negli USA: Sanven Technology Ltd.

Suite 250, 9166 Anaheim Place, Rancho Cucamonga, CA 91730

CARRITO SUBIR ESCALERAS

MODELO: 2025C

CARRITO SUBIR ESCALERAS

MODELO:2025C



INSTRUCCIONES DE SEGURIDAD

ADVERTENCIA:

1. No lo coloque cerca de materiales inflamables.
2. Está prohibido transportar personas bajo cualquier condición.
3. Preste atención a la seguridad al subir y bajar escaleras.
4. La sobrecarga está estrictamente prohibida.
5. No te muevas demasiado rápido al pasar por zonas con baches.

MODELO Y PARÁMETROS





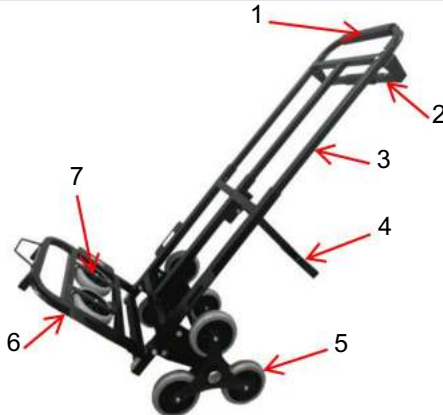





Modelo	2025C
Carga máxima (terreno plano)	460 libras
Carga máxima (subir escaleras)	220 libras
Color	Negro
Material	Acero+Caucho+PP

DIAGRAMA DE ESTRUCTURA Y COMPONENTES



- 1.Manija 1 2.Manija 2 3.Marco 4.Barra de soporte
5. Rueda de escalada 6. Bandeja 7. Ruedas de repuesto

COMPONENTES

 <p>A: Marco de carrito x1</p>	 <p>B: Marco de rueda x1</p>
 <p>C: Juegos de ruedas x2</p>	 <p>D: Tuercas x4</p>
 <p>E: Arandela x2</p>	 <p>F: Pernos x4</p>
 <p>G: Un candado de ciruela x2</p>	 <p>Cuerda elástica para atar x2</p>
 <p>Herramientas de instalación x2</p>	 <p>Manual de usuario x1</p>

ASAMBLEA

1. Coloque el marco (A) y luego instale el marco de la rueda (B).

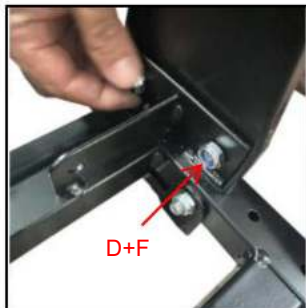

2. Coloque la arandela (C) en cada extremo.



3. Instale los juegos de ruedas (C).



4. Instale el bloqueo de plomada A (G). (Nota: Presione con fuerza).



MANTENIMIENTO

1. Evite la exposición prolongada al sol para evitar el envejecimiento.
2. Evite que los niños utilicen el carrito para subir escaleras para jugar.

Fabricante: Shanghaimuxinmuyeyouxiangongsi

Dirección: Shuangchenglu 803nong11hao1602A-1609shi, baoshanqu, shanghai 200000 CN.

REPRESENTANTE CE: E-CrossStu GmbH.

Mainzer Landstr.69, 60329 Fráncfort del Meno.

REPRESENTANTE DEL REINO UNIDO: YH CONSULTING LIMITED.

C/O YH Consulting Limited Oficina 147, Centurion House, London Road, Staines-upon-Thames, Surrey, TW18 4AX

Importado a AUS: SIHAO PTY LTD.

1 ROKEVA STREET EASTWOOD NSW 2122 Australia

Importado a EE. UU.: Sanven Technology Ltd.

Suite 250, 9166 Anaheim Place, Rancho Cucamonga, CA 91730

WÓZEK DO WSPINACZKI PO SCHODACH
MODEL: 2025C

WÓZEK DO WSPINACZKI PO SCHODACH

MODEL:2025C



INSTRUKCJE BEZPIECZEŃSTWA

OSTRZEŻENIE:

1. Proszę nie umieszczać w pobliżu materiałów łatwopalnych.
2. Zabrania się przewożenia osób w jakichkolwiek warunkach.
3. Prosimy zachować ostrożność podczas wchodzenia i schodzenia po schodach.
4. Przeciążanie jest surowo zabronione.
5. Nie poruszaj się zbyt szybko przy pokonywaniu dziur w drogach.

MODEL I PARAMETRY





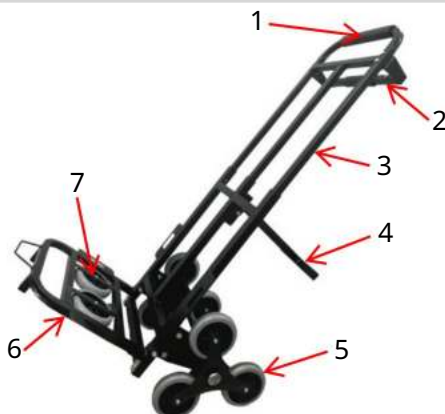





Model	2025C
Maksymalne obciążenie (płaskie podłoże)	460 funtów
Maksymalne obciążenie (wchodzenie po schodach)	220 funtów
Kolor	Czarny
Tworzywo	Stal + Guma + PP

SCHEMAT STRUKTURY I SKŁADNIKI



1. Uchwyt 1 2. Uchwyt 2 3. Rama 4. Pręt podporowy
5. Koło wspinaczkowe 6. Tacka 7. Koła zapasowe

SKŁADNIKI

 <p>A: Rama wózka x1</p>	 <p>B: Rama koła x1</p>
 <p>C: Zestawy kół x2</p>	 <p>D: Orzechy x4</p>
 <p>E: Podkładka x2</p>	 <p>F: Śruby x4</p>
 <p>G: Śliwkowy zamek x2</p>	 <p>Elastyczna lina wiążąca x2</p>
 <p>Narzędzia instalacyjne x2</p>	 <p>Instrukcja obsługi x1</p>

MONTAŻ

1. Umieść ramę (A), a następnie zamontuj ramę koła (B).

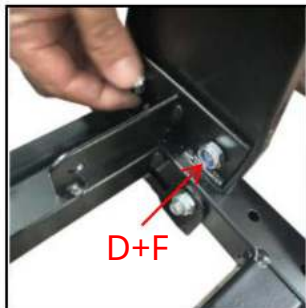

2. Załóż podkładkę (C) na każdy koniec.



3. Zamontuj zestawy kół (C).



4. Zamontuj blokadę śliwkową A (G). (Uwaga: Dociśnij ją mocno.)



KONSERWACJA

1. Unikaj długotrwałego wystawiania się na działanie promieni słonecznych, aby zapobiec starzeniu się skóry.

2. Nie pozwalaj dzieciom bawić się wózkiem po schodach.

Producent: Shanghaimuxinmuyeyouxiangongsi

Adres: Shuangchenglu 803nong11hao1602A-1609shi, baoshanqu, szanghaj 200000 CN.

Przedstawiciel KE: E-CrossStu GmbH.

Mainzer Landstr.69, 60329 Frankfurt nad Menem.

ODPOWIEDZIALNOŚĆ W WIELKIEJ BRYTANII: YH CONSULTING LIMITED.

C/O YH Consulting Limited Biuro 147, Centurion House, London Road,
Staines-upon-Thames, Surrey, TW18 4AX

Importowane do AUS: SIHAO PTY LTD.

1 ROKEVA STREETEASTWOOD NSW 2122 Australia

Importowane do USA: Sanven Technology Ltd.

Apartament 250, 9166 Anaheim Place, Rancho Cucamonga, CA 91730

TRAP KLIMWAGEN

MODEL: 2025C

TRAP KLIMWAGEN

MODEL:2025C



VEILIGHEIDSINSTRUCTIES

WAARSCHUWING:

1. Plaats het niet in de buurt van brandbare materialen.
2. Het is onder welke omstandigheden dan ook verboden om personen te vervoeren.
3. Let op de veiligheid wanneer u de trap op- en afgaat.
4. Overbelasting is ten strengste verboden.
5. Rijd niet te snel als u een kuil in de weg passeert.

MODEL EN PARAMETERS





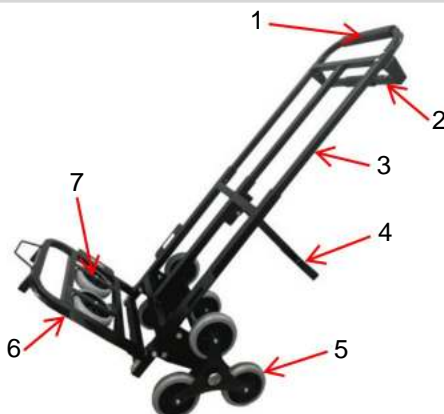





Model	2025C
Maximale belasting (vlakke grond)	460 pond
Maximale belasting (trappen beklimmen)	220 pond
Kleur	Zwart
Materiaal	Staal+Rubber+PP

STRUCTUURDIAGRAM EN COMPONENTEN



- 1.Handvat 1 2.Handvat 2 3.Frame 4.Steunbalk
5. Klimwiel 6. Bak 7. Reservewielen

COMPONENTEN

 <p>A: Karretjeframe x1</p>	 <p>B: Wielframe x1</p>
 <p>C: Wielsets x2</p>	 <p>D: Noten x4</p>
 <p>E: Ring x2</p>	 <p>F: Bouten x4</p>
 <p>G: Een pruimenslot x2</p>	 <p>Elastisch bindtouw x2</p>
 <p>Installatiegereedschap x2</p>	 <p>Gebruiksaanwijzing x1</p>

MONTAGE

1. Plaats het frame (A) en installeer vervolgens het wielframe (B).

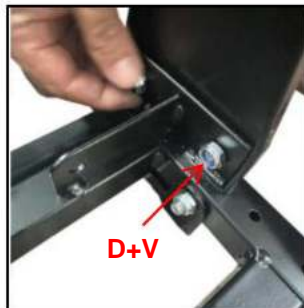

2. Plaats de ring (C) aan elk uiteinde.



3. Installeer de wielsets (C).



4. Plaats het A-plumslot (G). (Let op: druk er met kracht op.)



ONDERHOUD

1. Vermijd langdurige blootstelling aan de zon om veroudering te voorkomen.
2. Zorg ervoor dat kinderen niet met de trapklimkar spelen.

Fabrikant: Shanghai muxinmuyeyouxiangongsi

Adres: Shuangchenglu 803nong11hao1602A-1609shi, baoshanqu, shanghai 200000 CN.

EG-REP: E-CrossStu GmbH.

Mainzer Landstr.69, 60329 Frankfurt am Main.

VK VERTEGENWOORDIGING: YH CONSULTING LIMITED.

C/O YH Consulting Limited Kantoor 147, Centurion House, London Road, Staines-upon-Thames, Surrey, TW18 4AX

Geïmporteerd naar AUS: SIHAO PTY LTD.

1 ROKEVA STRAAT EASTWOOD NSW 2122 Australië

Geïmporteerd naar de VS: Sanven Technology Ltd.

Suite 250, 9166 Anaheim Place, Rancho Cucamonga, CA 91730

TRAPPKLÄTTERVAGN

MODELL: 2025C

TRAPPKLÄTTERVAGN

MODELL:2025C



SÄKERHETSINSTRUKTIONER

VARNING:

1. Placera den inte nära brandfarliga material.
2. Det är förbjudet att transportera människor under alla förhållanden.
3. Var uppmärksam på säkerheten när du går upp och ner för trappor.
4. Överbelastning är strängt förbjuden.
5. Rör dig inte för snabbt när du passerar gropar.

MODELL OCH PARAMETRAR





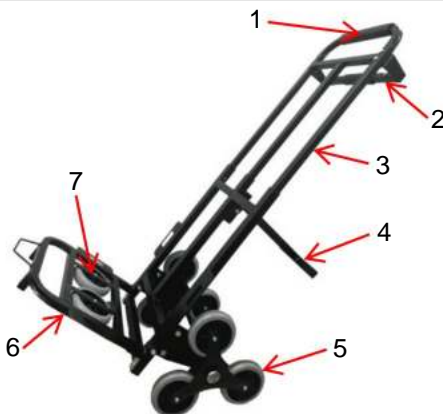





Modell	2025C
Maximal belastning (plan mark)	460 pund
Maximal belastning (klättra i trappor)	220 pund
Färg	Svart
Material	Stål+gummi+PP

STRUKTURDIAGRAM OCH KOMPONENTER



1. Handtag 1 2. Handtag 2 3. Ram 4. Stödstång
5. Klätterhjul 6. Bricka 7. Reservhjul

KOMPONENTER

 <p>A: Cart Frame x1</p>	 <p>B: Hjulram x1</p>
 <p>C: Hjuluppsättningar x2</p>	 <p>D: Nötter x4</p>
 <p>E: Bricka x2</p>	 <p>F: Bultar x4</p>
 <p>G: Ett plommonlås x2</p>	 <p>Elastiskt bindrep x2</p>
 <p>Installationsverktyg x2</p>	 <p>Användarmanual x1</p>

MONTERING

1. Placera ramen (A) och installera sedan hjulramen (B).

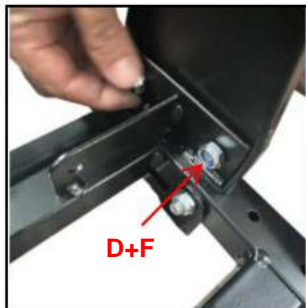

2. Sätt brickan (C) i varje ände.



3. Installera hjuluppsättningarna (C).



4. Installera A plommonlåset (G).(Obs! Tryck in med kraft.)



UNDERHÅLL

1. Undvik långvarig exponering för solen för att undvika åldrande.
2. Undvik att barn tar trappklättern för att leka.

Tillverkare: Shanghaimuxinmuyeyouxiangongsi

Adress: Shuangchenglu 803nong11hao1602A-1609shi, baoshanqu, shanghai 200000 CN.

EC REP: E-CrossStu GmbH.

Mainzer Landstr.69, 60329 Frankfurt am Main.

UK REP: YH CONSULTING LIMITED.

C/O YH Consulting Limited Office 147, Centurion House, London Road, Staines-upon-Thames, Surrey, TW18 4AX

Importerad till AUS: SIHAO PTY LTD.

1 ROKEVA STREETEASTWOOD NSW 2122 Australien

Importerad till USA: Sanven Technology Ltd.

Suite 250, 9166 Anaheim Place, Rancho Cucamonga, CA 91730

