

VTOMAN
TOOLS & BATTERIES

User Manual

**1500W Portable Power Station
Emergency Power Source**

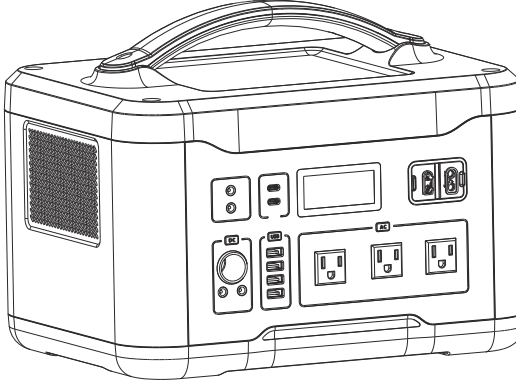

Model: Jump 1500X

Preface

Thank you for purchasing Jump 1500X portable power station. To make sure your personal safety, property security and user experience, please read this manual carefully before operating, and retain it for the future reference.

⚠️ Charge it first!
Before reading through the manual, you can begin to charge up your Jump 1500X by connecting it to the AC Adapter provided.

Please use the charger provided to charge the Jump 1500X!



WWW.VTOMAN.COM

Scan to get more information about VTOMAN products

1

Product Overview

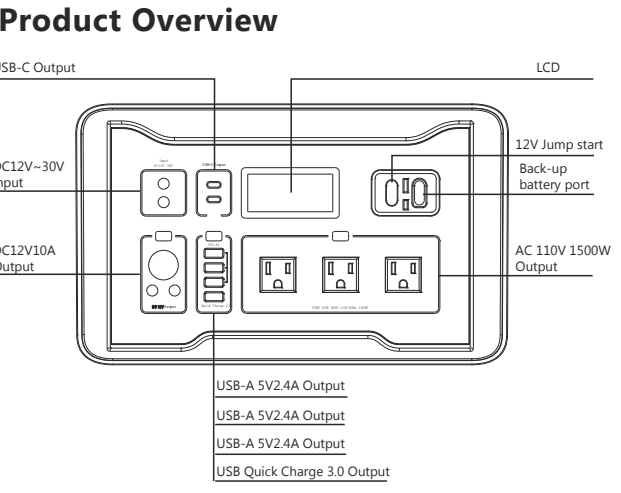

Labels in diagram: USB-C Output, LCD, DC12V-30V Input, 12V Jump start Back-up battery port, DC12V10A Output, AC 110V 1500W Output, USB-A 5V2.4A Output, USB-A 5V2.4A Output, USB-A 5V2.4A Output, USB Quick Charge 3.0 Output, USB cable, Power Check Buttons, Power Switch, Power Indicator.

LCD Screen

The LCD display will be on when you press any power switch. It will display charge and discharge. When you use this unit, it will display the **Battery Power, Available Time (Hours), Power Consumption (Watts)**.

2

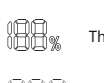

The current battery power, it is displayed as a percentage (%).



Available time at the current power.



Press the [DC] button to turn on the DC output function.



Press the [USB] button to turn on the USB output function.



Press the [TYPE-C] button and use a type-c to type-c cable to charge other devices, the type-c function icons will appear on the LCD screen.



Press the [AC] button to turn on the AC output function.

LED Flashlight

Press the [LED] button and the LCD display will be on, press the button one more time to turn on the LED light. There are 5 modes of LED light appear in order: Weak light, Medium light, Strong light, Strobe, SoSo. If you press slightly.

DC Input(12-30V)

- Support AC Adapter Charging.
- Support Solar Panel Charging (DC12-30V, Solar Panel Not Included).
- Support Car Charger Charging.

Power Switch

Press the power switch to turn on the corresponding output function and press the power switch one more time to turn it off, please turn off the corresponding functions (LED/USB/DC/AC) to save power after using.

SPECIFICATIONS			
Capacity	828Wh	DC Input	12V-30V (200W MAX)
DC Output	2 DC output+ 1* Car Output; Total 120W	AC Output	Pure Sine Wave 110V/60Hz; continuous 1500W, peak 3000W
USB Output	5V/2.4A*3 Quick Charge 3.0*1		

3

WHAT'S IN THE BOX

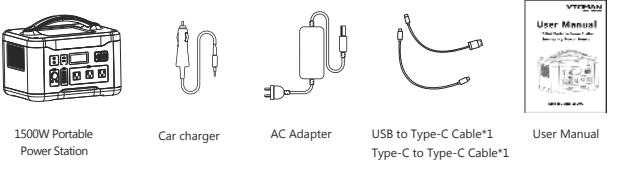

Support Charging Device

USB Output Port: Smart phones, Tablets, Smart watches, Digital Cameras, e-readers, etc.
12V Cigarette Lighter Socket: Car air pump, Car vacuum cleaners, Car refrigerators, etc.
DC Output Port: Drones, Routers, etc. use 12V as the power supply device.
AC Output Port: Laptops, Displays, Home appliances, etc.
Type-C Port: Support PD100W max output power for laptops and smart phone, etc devices with type-c port.

4

Recharging Method

Before using or storage, if the LCD display shows capacity less than 5%, please recharge the Jump 1500X as soon as possible. Connecting your Jump 1500X to the AC Adapter until it's fully charged. There are three ways to recharge it:

- AC Adapter (180W) 4-5 Hours
- Car Charger 5-6 Hours
- Support 60W-200W(MAX) Solar Panels. The charging time is determined by the solar light intensity.

How to Charge the Jump 1500X

AC Adapter Charging

Use the AC Adapter provided to charge this unit, the full charge time takes 4-5 hours.

When the LCD display shows the battery power of 100%, it indicates that this unit is fully charged.

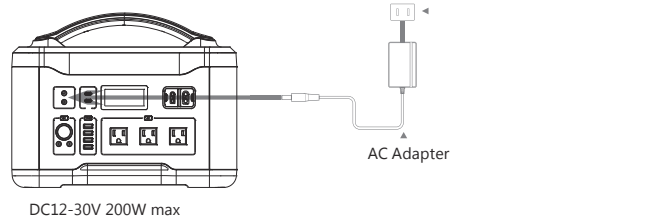

5

Solar Panel Charging

- Place Solar Panels in direct sunlight as much as possible.
- Support 60W-200W(MAX) Solar Panels. The charging time is determined by the solar light intensity.

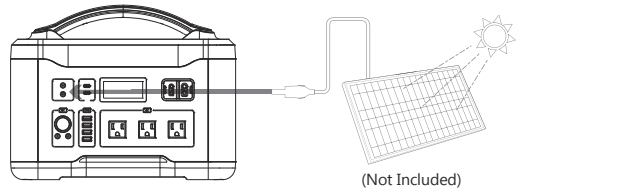

(Not Included)

12V Car Charger Charging

Use the Car Charger we provided to charge this unit. The full charge time takes 5-6 hours. When the LCD display shows the battery power of 100%, it indicates that this unit is fully charged.

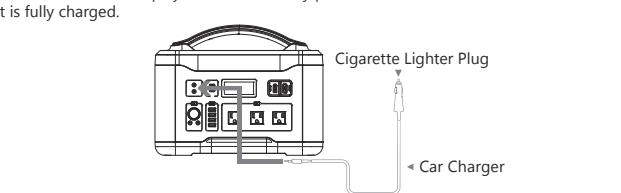

6

Caution

- During charging, the battery power will be displayed on the LCD screen. When the battery power is 100%, this unit is fully charged. Please disconnect the charger after the charging process is finished.
- To avoid interference, please keep it away from TVs and radios while charging.

6

How To Jump Start Your Vehicle

Jump 1500X is designed for jump starting 12V vehicle batteries.

Step 1: Fully plug the blue connector of the clamp cable into the jump starter socket, and make sure the Indicator on the clamp cable is off.

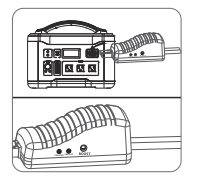

Step 2: Connect Red Clamp to the negative(+) battery terminal and Black Clamp to the negative(-) battery terminal.

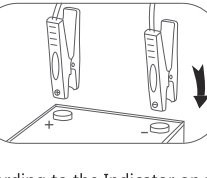

Step 3: Operate according to the Indicator on the clamp cable:
GREEN LIGHT on: Telling the connection is correct and the circuit is working, you can turn on the engine to jump start directly.

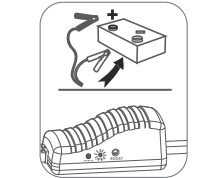

7

RED LIGHT on with buzzing: Telling the connection is wrong, and buzzing to alarm to correct the clamps as step 2 mentioned above, wait until the GREEN LIGHT is on to turn on the engine.

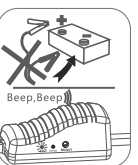

GREEN LIGHT blinking: Telling the vehicle battery is low, press the "BOOST" button, wait till GREEN LIGHT becomes solid, then turn on the engine within 30s.

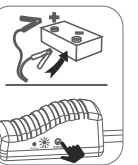

No Lights on, No buzzing: Telling the vehicle's battery may be damaged, after confirming that the clamps connection is correct, press the "BOOST" button, wait till GREEN LIGHT is on, and then turn on the engine within 30s.

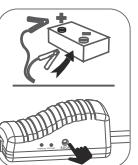

8

Step 4: Start the vehicle.

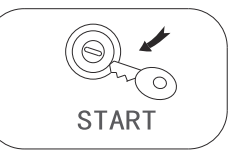

START

Step 5: When the vehicle is started, remove the clamp cable from the jump starter first, then remove the clamps from your vehicle battery.

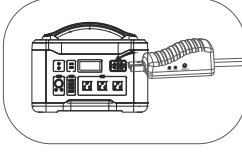

CAUTION:

- Occasionally, the jump starter will lock itself down for safety, due to (a) short-circuit, (b) over-current, (c) over-temperature, (d) over/low-voltage, (e) reverse-connection. Once it happens, turn off the jump starter and remove the battery clamps from your car battery, restart the jump starter & connect the battery back on the battery, try it again.
- If the vehicle does not start within 3 seconds, stop starting and wait at least 30 seconds before attempting to restart the vehicle. Don't jump start the vehicle continuously more than four times as it may damage the unit. Check your vehicle for other possible reasons of not starting.

If you need this accessory, you need to buy it separately.

9

Operation Instructions

- The LCD display will lit and the function will turn on at the same time when you press any corresponding power switch.
- When the function icons appear on the LCD screen, it means that the output function is turned on and can power for other devices, when the function icons disappear on the LCD screen, it means that the output function is turned off.
- The AC output port can only power the devices with operating power less than 1500-Watt. The AC output function will shut off automatically if the continuous power is exceeded 1500W, which can ensure the Jump 1500X will not be damaged due to overload.
- If you do not use this unit for a long time, it should be recharged every 3 months and the battery power should be kept at more than 80% and store it in a ventilated and dry place.
- In order to save power, if this unit has no power consumption and all output functions are turned off, it will be automatically turned off in 30 seconds.
- Please turn off the corresponding function to save power after using. If you forgot to turn off the power switch, this unit has intelligent detection function, it will be automatically turned off after 6 hours.
- In order to maximize the battery capacity, it is recommended to use it in an environment of 32°F-104°F.
- In order to maintain the life of this unit (lithium battery), please do not run out of the battery power. When the battery power is 5% or less, please recharge this unit immediately.

USB Output

You can connect a standard USB cable to the 5V/2.4A USB output port to charge the smart devices.

Quick Charge 3.0 USB Output

It supports 5V to 12V output up to 18W and can power Quick charge 3.0 compatible smart devices. The actual output voltage and current depend on the smart devices.

Type-C Output

It supports 5V to 20V output up to 100W and can power Type-C compatible smart devices. The actual output voltage and current depend on the smart devices.

10

DC Output (Rated Output 120W)

●12V Cigarette Lighter Socket Output

Connect the devices that need to be powered by 12V Cigarette Lighter Socket, like Car air pump, Car vacuum cleaners, Car refrigerators, etc.

●2*12V DC Output (120W Max)

Connect the devices that need to be powered by the 12V DC output ports. Please check if the device supports a 5.5mm DC plug with 12V DC input (the diameter of this unit's DC port: 5.5*2.1mm). If not, you will not be able to use it.

Protection Mode

Short-circuit/Over-load Protection: If the DC ports are short-circuited or overload (load power>120W), this unit will turn off the DC output function for self-protection. Resolve short-circuit or overload problems and press the [DC] button to reset from protection mode.

AC Output (Rated Power 1500W, Peak 3000W)

The output voltage of the AC port is 110V and the output frequency is 60Hz. Power the electronic devices with power consumption less than 1500W, such as laptops and displays, home appliances, etc.

Protection Mode

Short-circuit/Over-load Protection: If the AC port is short-circuited or overload (load power>1500W), this unit will turn off the AC output for self-protection. Some appliances like refrigerators and ice makers may require exceed 1500W surge power during startup or operation and this unit may enter overload protection mode. Resolve short-circuit or overload problems and press the [AC] button to reset from protection mode.

Temperature Protection: When the operating temperature reaches 131°F, the fan starts up. If the temperature of this unit is above 194°F, it will turn off the AC output for self-protection. Please reuse this unit after the temperature drops to the normal.

11

Safety Instructions

⚠️ DANGER

Noncompliance may very likely lead to serious injury or death.

- DO NOT disassemble, repair or modify the unit or the battery.
- DO NOT expose the product to fire or excessive temperatures. It will explode if the temperature is over 266°F. Keep out of direct sunlight.
- DO NOT charge, use or store the unit in a bathroom or in an area exposed to rain or moisture.
- Only use the output socket to power external devices. Never connect the output to mains power under any condition.
- DO NOT touch the unit or the plug-in points if your hands are wet.
- DO NOT connect any metallic objects to the AC input or output.
- DO NOT rub your eyes if fluid from inside the unit should get in your eyes.
- DO NOT dispose the unit together with household waste.
- DO NOT use any inappropriate power cords.
- DO NOT operate the unit above the specified input voltage.
- DO NOT use the unit if it is not functioning correctly.
- DO NOT drop the unit if it is recharging or in use.

⚠️ WARNING

Noncompliance may lead to serious injury or death

Use and store the unit only in a clean and dry environment. DO NOT use and store in dusty and wet environment.

- DO NOT use the unit if it is damaged or broken. Check the unit prior to every use.
- DO NOT use the unit if the power cord is damaged or broken.
- Keep the unit away from children. DO NOT let children use the power supply unit.
- Keep this product away from pets.
- DO NOT use or store the unit in an area or environment with high temperature.
- Should fluid from inside of the unit come in contact with your skin or clothing, wash the affected areas with tap water.
- In a storm, unplug the power cord from the socket.
- DO NOT charge the unit via power supply systems that operate outside of 100-240V.
- DO NOT place the unit on its side or upside down while in use or storage.
- DO NOT use accessories for other usage.

12

⚠️ CAUTION

Noncompliance may lead to injuries and/or property damage.

- If peculiar odors, overheating or other abnormal circumstances are observed, stop using the unit immediately and contact our customer service.
- The unit complies with all legal requirements for transport of dangerous goods.
- Make sure that the unit is properly secured when transporting it in a motor vehicle.
- Only charge, use and store the unit within an ambient temperature of 0 to 45°C (32-113°F).
- Switch the unit off immediately if it has accidentally fallen, was dropped or was exposed to vibrations.
- Carefully read the instructions for the electric devices that you intend to connect to your power supply unit.
- Please remove power plug when the product is not in use.

ATTENTION	
	Not permitted on aircrafts
	To preserve the battery lifespan, please use and recharge at least once every 3 months
	Use original or certified charger and cables
	Avoid extreme temperature
	Avoid dropping
	Do not disassemble

13

	It's not waterproof, do not expose to liquids
	Please dispose of batteries and electronic goods in accordance with local regulations

Disclaimer

- Our company cannot be held liable for damages caused by fire, earthquake, use by a third party, other accidents, intentional misconduct on the part of the customer, abuse or other abnormal conditions.
- Do not repair any damage to the AC plug or power supply on your own.
- The warranty covers all terms and conditions of the warranty. Contents that are not specified in the warranty terms and conditions are beyond our responsibility.
- Our company assumes no liability for damages caused by incorrect use or non-compliance with this instruction manual.

Intended Use: The Jump 1500X portable power station is intended as a power supply for electronic devices with a maximum power consumption of 1500W. Our product is not suitable to be used with equipment that relates to one's own personal safety and relies heavily on electricity, such as large medical devices, equipment for nuclear facilities, the manufacture of air and spacecraft, etc. We therefore assume no liability for accidents involving personal safety, fires, or machine failures, caused by using our product with the aforementioned devices.

Warranty

Warranty Period

The warranty period is 12+6 months. In each case, the warranty period is measured starting on the date of purchase by the original purchaser. The sales receipt from the first consumer purchase, or other reasonable documentary proof, is required in order to establish the start date of the warranty period.

14

FAQS

Q1: What type of battery is in Jump 1500X?
A1: Jump 1500X contains a battery pack which consist of LiFePO4.

Q2: How do I know if my Jump 1500X is charging?
A: Check the LCD Display, if the battery percentage blinks, it indicates the Jump 1500X is charging.

Q3: Can I charge the Jump 1500X while powering other devices at the same time?
A: The Jump 1500X could power other devices while recharging itself.

Q4: How do I know if my device will work with the Jump 1500X?
A: You need to check the rated power and start power of your devices. This may require some research on your end. An online search or examining the user guide for your device should suffice. To be compatible with the Jump 1500X you should use devices that require less than 1500W.

Q5: What is the maximum output power of 12V DC port or Cigarette Lighter Socket?
A: Cigarette Lighter Socket+ 2 x DC Ports total output is 120W, if only use the Cigarette Lighter Socket or 1 of 2 DC Ports, the output power is also 120W. Total load power over 120W will trigger the overload protection.

Q6: How to turn off the LCD display of the Jump 1500X?
A: Please turn off the AC/USB/DC/LED power switch when the Jump 1500X is not in use. When the AC/USB/DC function icons don't show on the LCD screen, it means all the functions have been turned off, then the LCD display will shut off in 30 seconds.

15

MADE IN CHINA

Customer Service

- 12+12 Months Limited Warranty Service
- Lifetime Technical Service
- Feel Free to Contact Us
contact@vtoman.com (recommend)
- For FAQ and More Information
www.vtoman.com
- Facebook : @Vtoman2022
- Youtube : @Vtoman
- Twitter : @Vtoman

16