

VTOMAN
TOOLS & BATTERIES

User Manual

1800W Portable Power Station

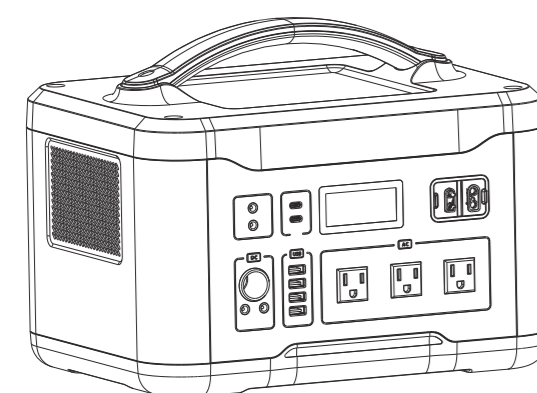

Model: Jump 1800

Preface

Thank you for purchasing Jump 1800 portable power station. To make sure your personal safety, property security and user experience, please read this manual carefully before operating, and retain it for the future reference.

⚠️ Charge it first!
Before reading through the manual, you can begin to charge up your Jump 1800 by connecting it to the AC Adapter provided.

Please use the charger provided to charge the Jump 1800!



Scan to get more information about VTOMAN products

Product Overview

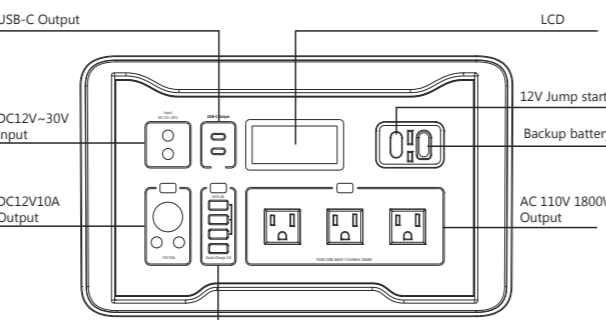

DC12V-30V Input, DC12V10A Output, USB-A 5V2.4A Output, USB-A 5V2.4A Output, USB-A 5V2.4A Output, USB Quick Charge 3.0 Output, 12V Jump starter port, Backup battery port, AC 110V 1800W Output, LCD.

LCD Screen

The LCD display will be on when you press any power switch, it will display charge and discharge. When you use this unit, it will display the **Battery Power, Available Time (Hours), Power Consumption (Watts), Output Methods.**

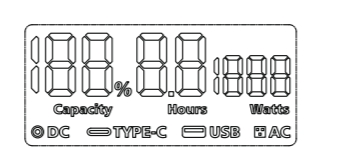

⚡ The current battery power, it is displayed as a percentage (%).

🕒 Available time at the current power.

🔌 The current total output power.

⏻ Press the [DC] button to turn on the DC output function.

🔌 Press the [USB] button to turn on the USB output function.

🔌 Press the [USB] button and use a type-c to type-c cable to charge other devices, the type-c function icons will appear on the LCD screen.

🔌 Press the [AC] button to turn on the AC output function.

LED Flashlight

Press the (LED) button and the LCD display will be on, press the button one more time to turn on the LED light. There are 5 modes of LED light appear in order(Weak light, Medium light, Strong light, Strobe, SOS) if you press slightly.

DC Input(12-30V)

- Support AC Adapter Charging.
- Support Solar Panel Charging (DC12-30V, Solar Panel Not Included).
- Support Car Charger Charging.

Power Switch:

Press the power switch to turn on the corresponding output function and press the power switch one more time to turn it off, please turn off the corresponding functions (LED/USB/DC/AC) to save power after using.

SPECIFICATIONS

| | | | |
|-----------|--|------------|--|
| Capacity | 1548Wh | DC Input | 12V-30V (200W MAX) |
| DC Output | 2 DC output+ 1* Car output: Total 120W | AC Output | Pure Sine Wave 110V/60Hz, continuous 1800W, peak 3600W |
| AC Output | | USB Output | 5V/2.4A*3 Quick Charge 3.0* |

WHAT'S IN THE BOX

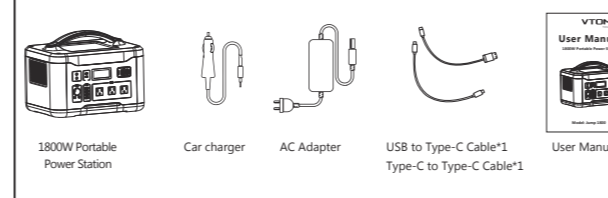

Support Charging Device

USB Output Port: Smart phones, Tablets, Smart watches, Digital Cameras, e-readers, etc.
12V Cigarette Lighter Socket: Car air pump, Car vacuum cleaners, Car refrigerators, etc.
DC Output Port: Laptops, Displays, Home appliances, etc.
Type-C Port: Support PD100W max output power for laptops and smart phone, etc.

Recharging Method

Before using or storage, if the LCD display shows capacity less than 5%, please recharge the Jump 1800 as soon as possible. Connecting your Jump 1800 to the AC Adapter until it's fully charged. There are three ways to recharge it:

- AC Adapter (180W) 8-9 Hours
- Car Charger 9-10 Hours
- Supports 12-30V solar panels with DC5521 connector. The charging time is determined by the solar light intensity.

How to Charge the Jump 1800

AC Adapter Charging

Use the AC Adapter we provided to charge this unit, the full charge time takes 8-9 hours. When the LCD display shows the battery power of 100%, it indicates that this unit is fully charged.

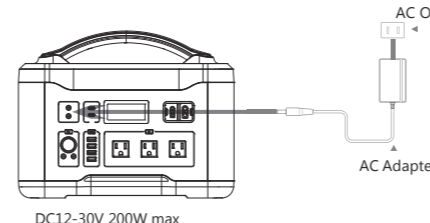

Solar Panel Charging

① Place Solar Panels in direct sunlight as much as possible.
② Supports 12-30V solar panels with DC5521 connector, the charging time is determined by the solar light intensity.

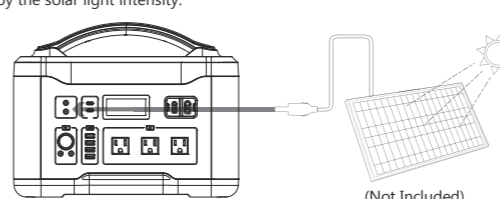

(Not Included)

12V Car Charger Charging

Use the Car Charger we provided to charge this unit. The full charge time takes 9-10 hours. When the LCD display shows the battery power of 100%, it indicates that this unit is fully charged.

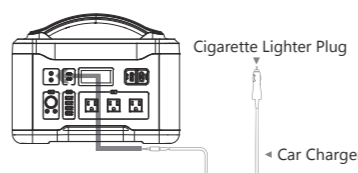

Cigarette Lighter Plug, Car Charger

Caution

- During charging, the battery power will be displayed on the LCD screen. When the battery power is 100%, this unit is fully charged. Please disconnect the charger after the charging process is finished.
- To avoid interference, please keep it away from TVs and radios while charging.

How To Jump Start Your Vehicle

Jump 1800 is designed for jump starting 12V vehicle batteries. Start current: 500A Peak current: 2000A.

Step 1: Fully plug the blue connector of the clamp cable into the jump starter socket, and make sure the Indicator on the clamp cable is off.

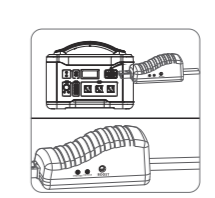

Step 2: Connect Red Clamp to the negative(+) battery terminal and Black Clamp to the negative(-) battery terminal.

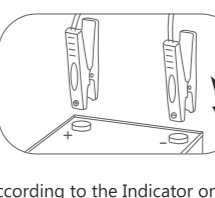

Step 3: Operate according to the Indicator on the clamp cable: **GREEN LIGHT on:** Telling the connection is correct and the circuit is working, you can turn on the engine to jump start directly.

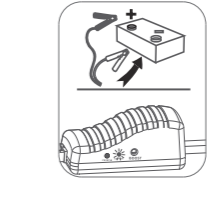

RED LIGHT on with buzzing: Telling the connection is wrong, and buzzing to alarm to correct the clamps as step 2 mentioned above, wait until the GREEN LIGHT is on to turn on the engine.

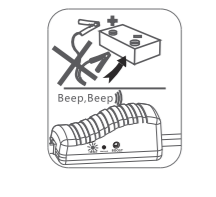

GREEN LIGHT blinking: Telling the vehicle battery is low, press the "BOOST" button, wait till GREEN LIGHT becomes solid, then turn on the engine within 30s.

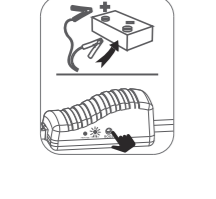

No Lights on, No Buzzing: Telling the vehicle's battery may be damaged, after confirming that the clamps connection is correct, press the "BOOST" button, wait till GREEN LIGHT is on, and then turn on the engine within 30s.

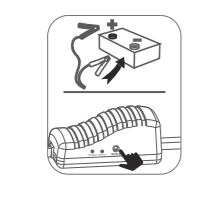

Step 4: Start the vehicle.

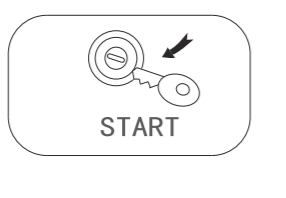

Step 5: When the vehicle is started, remove the clamp cable from the jump starter first, then remove the clamps from your vehicle battery.

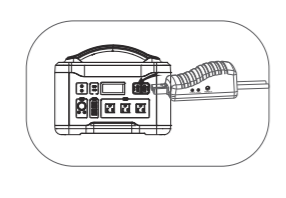

If you need this accessory, you need to buy it separately.

Operation Instructions

- The LCD display will lit and the function will turn on at the same time when you press any corresponding power switch.
- When the function icons appear on the LCD screen, it means that the output function is turned on and can power for other devices, when the function icons disappear on the LCD screen, it means that the output function is turned off.
- If you do not use this unit for a long time, it should be recharged every 3 months and the battery power should be kept at more than 80% and store it in a ventilated and dry place.
- In order to save power, if this unit has no power consumption and all output functions are turned off, it will be automatically turned off in 30 seconds.
- When any output switch of the battery is turned on, the battery will maintain continuous output for 6 hours. After 6 hours, the battery starts to detect the load current and lasts for 2 hours. There are three situations as follows:
 - If no load is detected within 2 hours, the battery will automatically shut down;
 - When the load is detected within 2 hours, the battery will continue to output;
 - If it is detected that the load is turned on and then turned off within 2 hours, the load detection will be restarted for 2 hours after the load is turned off.
- In order to maximize the battery capacity, it is recommended to use it in an environment of 32°F-104°F.
- In order to maintain the life of this unit (lithium battery), please do not run out of the battery power. When the battery power is 5% or less, please recharge this unit immediately.
- When the total operating power of the devices connected to the battery's AC socket exceeds the battery's 1800W rated power, Jump 1800 will not automatically disconnect the AC output, but will continue to output at a constant power of 1800W. But when the operating power of your device exceeds 160%-180% of the rated power of the battery (when the operating power exceeds 2880W-3240W), the battery may disconnect the AC output function.

USB Output

You can connect a standard USB cable to the 5V/2.4A USB output port to charge the smart devices.

Quick Charge 3.0 USB Output

It supports 5V to 12V output up to 18W and can power Quick charge 3.0 compatible smart devices. The actual output voltage and current depend on the smart devices.

Type-C Output

It supports 5V to 20V output up to 100W and can power type-C compatible smart devices. The actual output voltage and current depend on the smart devices.

DC Output

●12V Cigarette Lighter Socket Output

Connect the devices that need to be powered by 12V Cigarette Lighter Socket, like Car air pump, Car vacuum cleaners, Car refrigerators, etc.

●2*12V DC Output (120W Max)

Connect the devices that need to be powered by the 12V DC output ports. Please check if the device supports a 5.5mm DC plug with 12V DC input (the diameter of this unit's DC port: 5.5*2.1mm). If not, you will not be able to use it.

Protection Mode

Short-circuit/Over-load Protection: If the DC ports are short-circuited or overload (load power>120W), this unit will turn off the DC output function for self-protection. Resolve short-circuit or overload problems and press the [DC] button to reset from protection mode.

AC Output (Rated Power 1800W, Peak 3600W)

The output voltage of the AC port is 110V and the output frequency is 60Hz. Power the electronic devices with power consumption less than 1800W, such as laptops and displays, home appliances, etc.

Protection Mode

Short-circuit/Over-load Protection: If the AC port is short-circuited or overload (load power>1800W), this unit will turn off the AC output for self-protection. Some appliances like refrigerators and ice makers may require exceed 1800W surge power during startup or operation and this unit may enter overload protection mode. Resolve short-circuit or overload problems and press the [AC] button to reset from protection mode.

Temperature Protection: When the operating temperature reaches 131°F, the fan starts up. If the temperature of this unit is above 194°F, it will turn off the AC output for self-protection. Please reuse this unit after the temperature drops to the normal.

Safety Instructions

⚠️ DANGER

Noncompliance may very likely lead to serious injury or death.

- DO NOT disassemble, repair or modify the unit or the battery.
- DO NOT expose the product to fire or excessive temperatures. It will explode if the temperature is over 266°F. Keep out of direct sunlight.
- DO NOT charge, use or store the unit in a bathroom or in an area exposed to rain or moisture.
- Only use the output socket to power external devices. Never connect the output to mains power under any condition.
- DO NOT touch the unit or the plug-in points if your hands are wet.
- DO NOT connect any metallic objects to the AC input or output.
- DO NOT rub your eyes if fluid from inside the unit should get in your eyes.
- DO NOT dispose the unit together with household waste.
- DO NOT use any inappropriate power cords.
- DO NOT operate the unit above the specified input voltage.
- DO NOT use the unit if it is not functioning correctly.
- DO NOT drop the unit if it is recharging or in use.

⚠️ WARNING

Noncompliance may lead to serious injury or death

- Use and store the unit only in a clean and dry environment. DO NOT use and store in dusty and wet environment.
- DO NOT use the unit if it is damaged or broken. Check the unit prior to every use.
- DO NOT use the unit if the power cord is damaged or broken.
- Keep the unit away from children. DO NOT let children use the power supply unit.
- Keep this product away from pets.
- DO NOT use or store the unit in an area or environment with high temperature.
- Should fluid from inside of the unit come in contact with your skin or clothing, wash the affected areas with tap water.
- In a storm, unplug the power cord from the socket.
- DO NOT charge the unit via power supply systems that operate outside of 100-240V.
- DO NOT place the unit on its side or upside down while in use or storage.
- DO NOT use accessories for other usage.

CAUTION

Noncompliance may lead to injuries and/or property damage.

- If peculiar odors, overheating or other abnormal circumstances are observed, stop using the unit immediately and contact our customer service.
- The unit complies with all legal requirements for transport of dangerous goods.
- Make sure that the unit is properly secured when transporting it in a motor vehicle.
- Only charge, use and store the unit within an ambient temperature of 0 to 45°C (32-113°F).
- Switch the unit off immediately if it has accidentally fallen, was dropped or was exposed to vibrations.
- Carefully read the instructions for the electric devices that you intend to connect to your power supply unit.
- Please remove power plug when the product is not in use.

| ATTENTION | |
|-----------|--|
| | Not permitted on aircrafts |
| | To preserve the battery lifespan, please use and recharge at least once every 3 months |
| | Use original or certified charger and cables |
| | Avoid extreme temperature |
| | Avoid dropping |
| | Do not disassemble |

It's not waterproof, do not expose to liquids

Please dispose of batteries and electronic goods in accordance with local regulations

Disclaimer

- Our company cannot be held liable for damages caused by fire, earthquake, use by a third party, other accidents, intentional misconduct on the part of the customer, abuse or other abnormal conditions.
- Do not repair any damage to the AC plug or power supply on your own.
- The warranty covers all terms and conditions of the warranty. Contents that are not specified in the warranty terms and conditions are beyond our responsibility.
- Our company assumes no liability for damages caused by incorrect use or non-compliance with this instruction manual.

Intended Use: The Jump 1800 portable power station is intended as a power supply for electronic devices with a maximum power consumption of 1800W. Our product is not suitable to be used with equipment that relates to one's own personal safety and relies heavily on electricity, such as large medical devices, equipment for nuclear facilities, the manufacture of air and spacecraft, etc. We therefore assume no liability for accidents involving personal safety, fires, or machine failures, caused by using our product with the aforementioned devices.

Warranty Period

The warranty period is 24 months. In each case, the warranty period is measured starting on the date of purchase by the original purchaser. The sales receipt from the first consumer purchase, or other reasonable documentary proof, is required in order to establish the start date of the warranty period.

FAQS

Q1: What type of battery is in Jump 1800?
A: Jump 1800 contains a battery pack which consist of LiFePO4.

Q2: How do I know if my Jump 1800 is charging?
A: Check the LCD Display, if the battery percentage blinks, it indicates the Jump 1800 is charging.

Q3: Can I charge the Jump 1800 while powering other devices at the same time?
A: The Jump 1800 could power other devices while recharging itself.

Q4: How do I know if my device will work with the Jump 1800?
A: You need to check the rated power and start power of your devices. This may require some research on your end. An online search or examining the user guide for your device should suffice. To be compatible with the Jump 1800 you should use devices that require less than 1800W.

Q5: What is the maximum output power of 12V DC port or Cigarette Lighter Socket?
A: Cigarette Lighter Socket+2 x DC Ports total output is 120W, if only use the Cigarette Lighter Socket or 1 of 2 DC Ports, the output power is also 120W. Total load power over 120W will trigger the overload protection.

Q6: How to turn off the LCD display of the Jump 1800?
A: Please turn off the AC/USB/DC/LED power switch when the Jump 1800 is not in use. When the AC/USB/DC function icons don't show on the LCD screen, it means all the functions have been turned off, then the LCD display will shut off in 30 seconds.



MADE IN CHINA

Customer Service

- 12+12 Months Limited Warranty Service
- Lifetime Technical Service
- Feel Free to Contact Us
contact@vtoman.com (recommend)
- For FAQ and More Information
www.vtoman.com
- Facebook : @Vtoman2022
- Youtube : @Vtoman
- Twitter : @Vtoman