

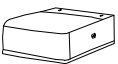

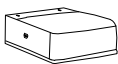

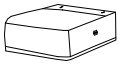

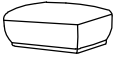

Installation & Assembly

Accessories List

 (A) Left sofa Base(1)	 (B) Right sofa Base(1)
 (C) Middle sofa Base(2)	 (D) Back rest(4)
 (E) Ottoman(2)	 (F) Pillow (4)
 (G) Leg(24)	 (H) Connector screw(3)
 (L) Left Armrest(1)	 (R) Right Armrest(1)

STEP2:

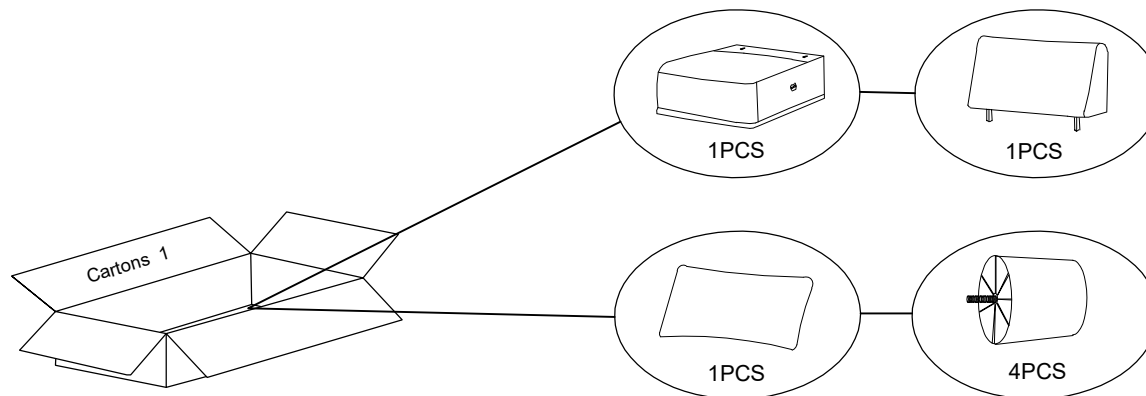

STEP3:

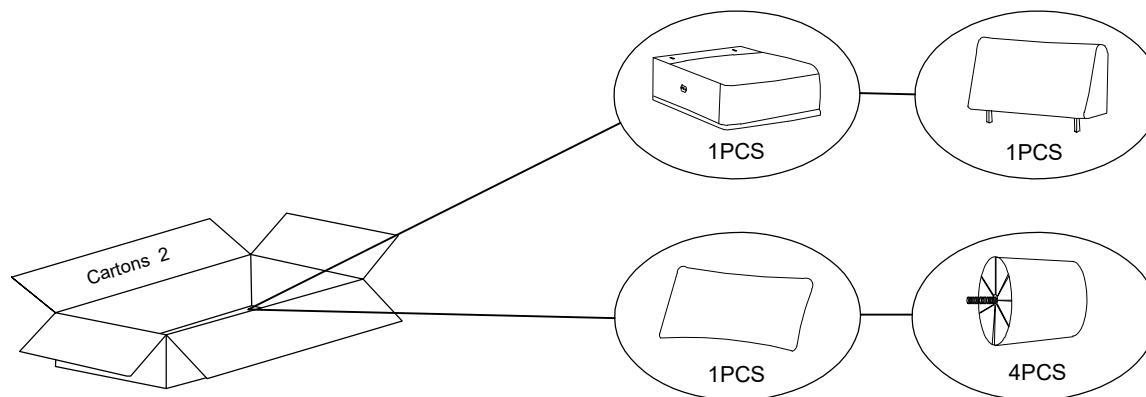

STEP4: Please take 2 legs from the Cartons 1.
Please take 2 legs from the Cartons 2.

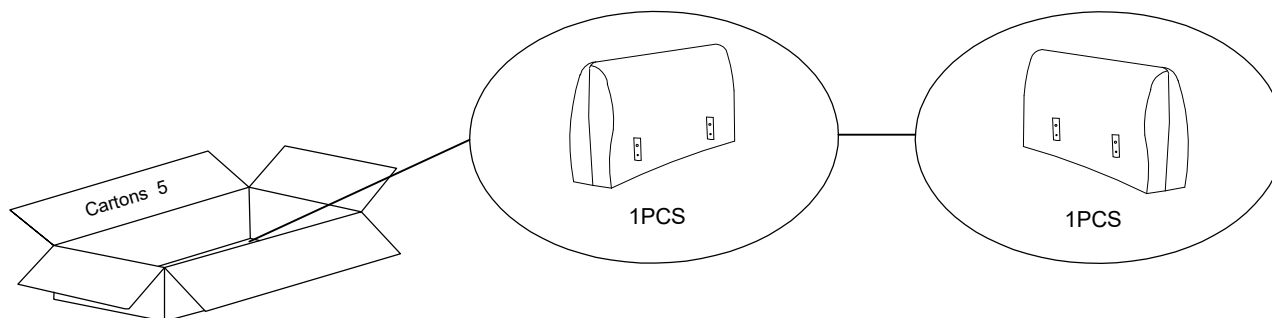

STEP1: Unzip and remove the legs from the bottom of the legs.

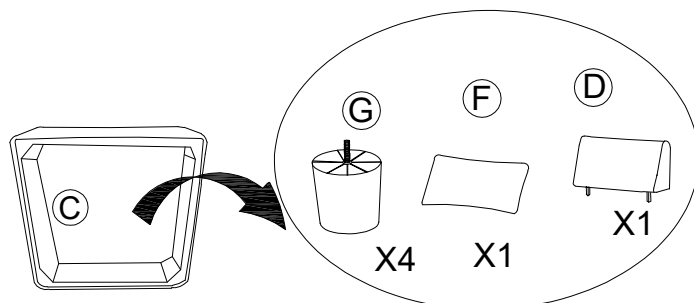
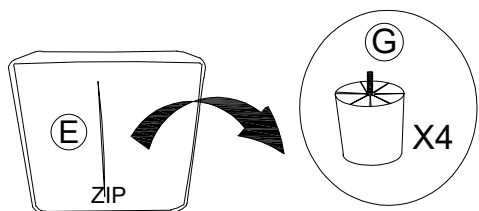

STEP5:Screw the legs clockwise into the hole at the bottom of the sofa.

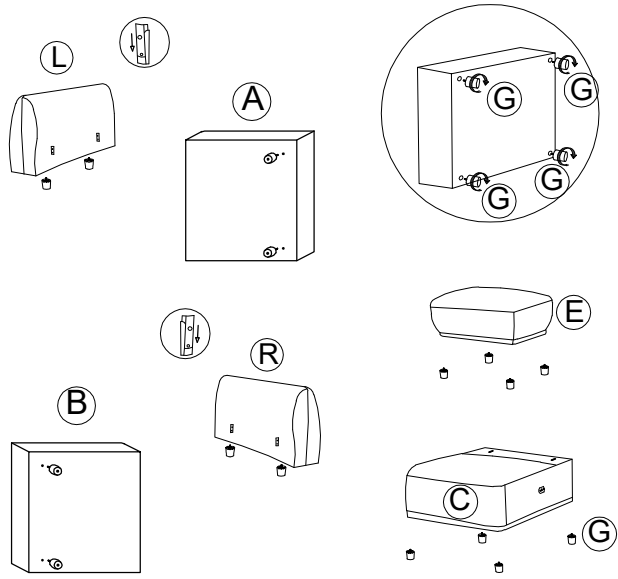

STEP6:Stand up the sofa, the sofa and the wooden frame on both sides of the handrail are flat, the handrail is moved from the bottom to the top, so that the handrail latch is inserted into the latch of the seat frame

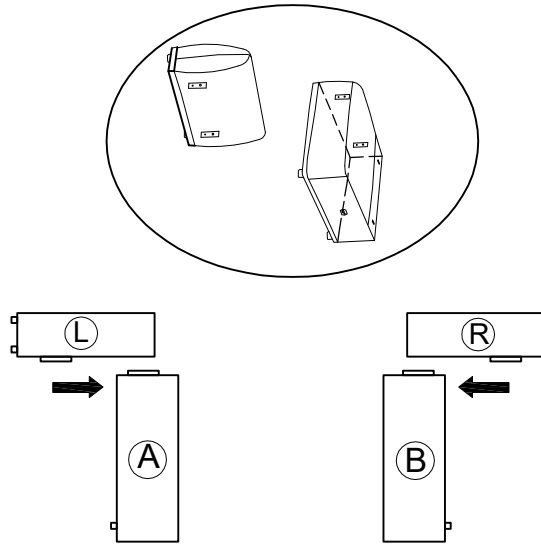

STEP7:Insert the backrest into the sofa seat.

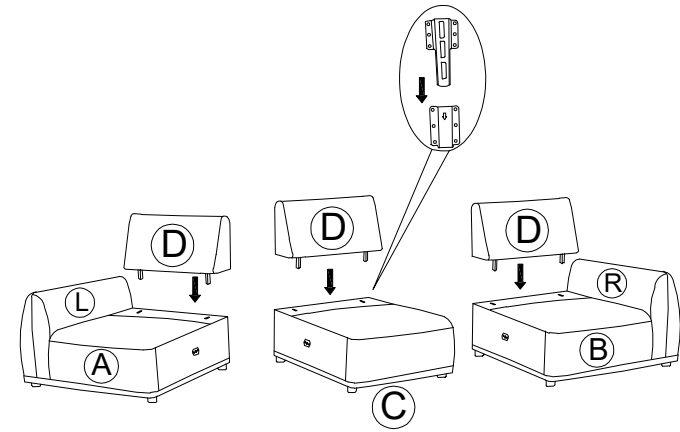

STEP8:Turn the connector screw clockwise into the black fitting on the right side of the sofa.

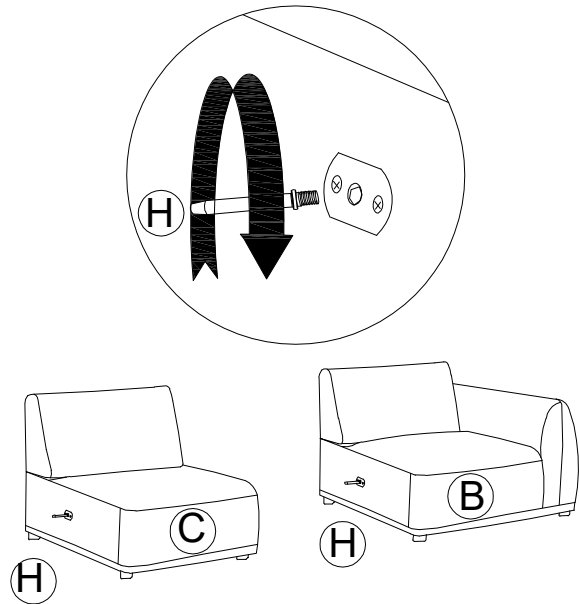

STEP9 :Connect the sofas as shown.

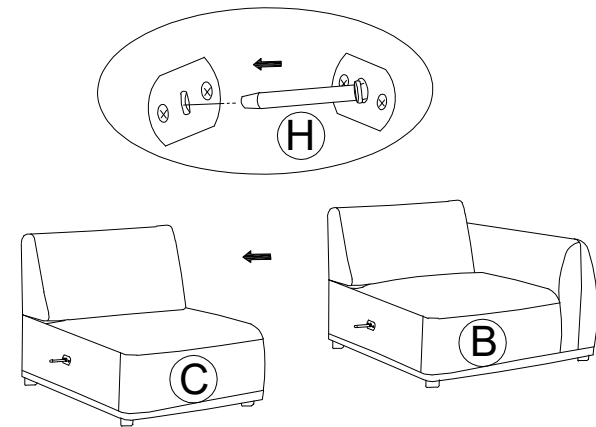

STEP10:Put the four pillows on.

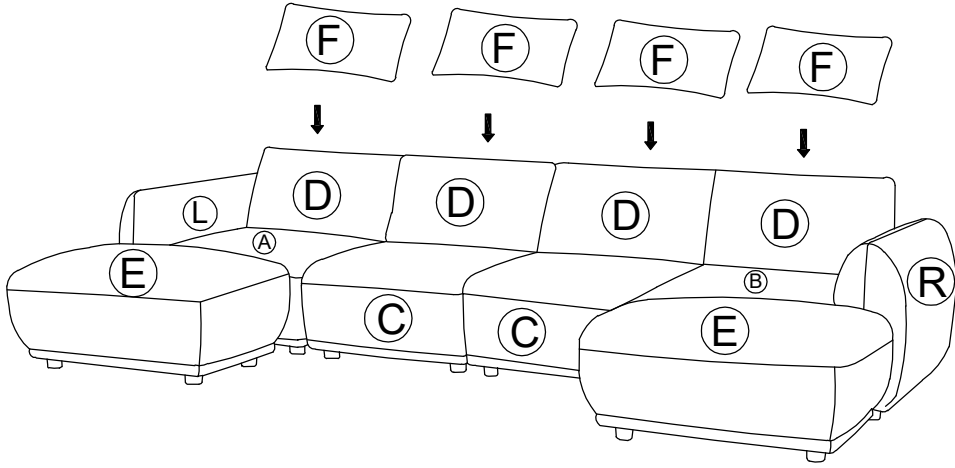

Complete

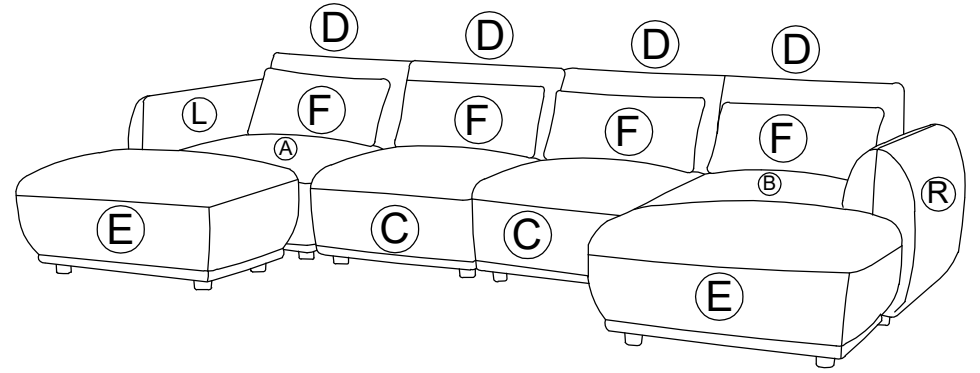

Complete

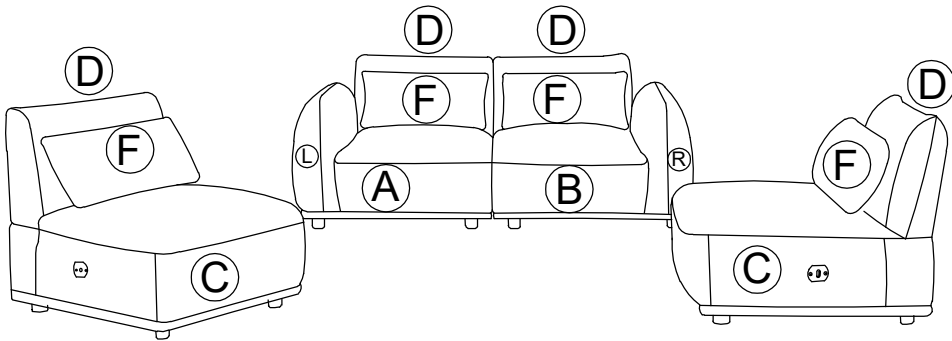

Complete

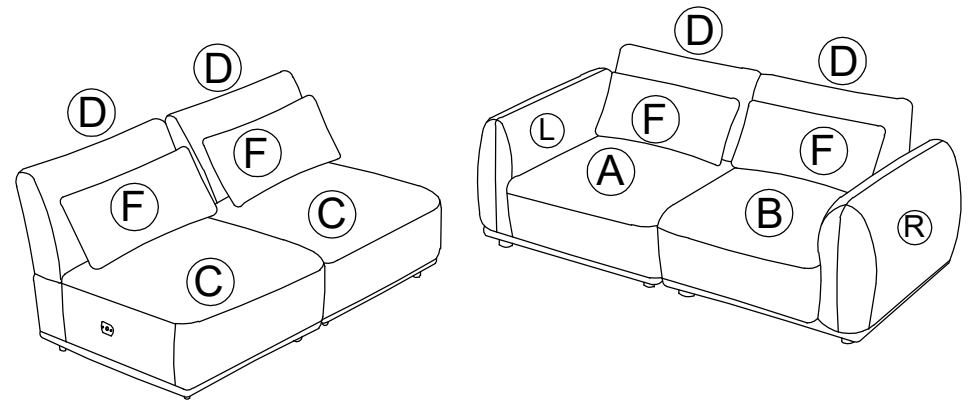

Complete

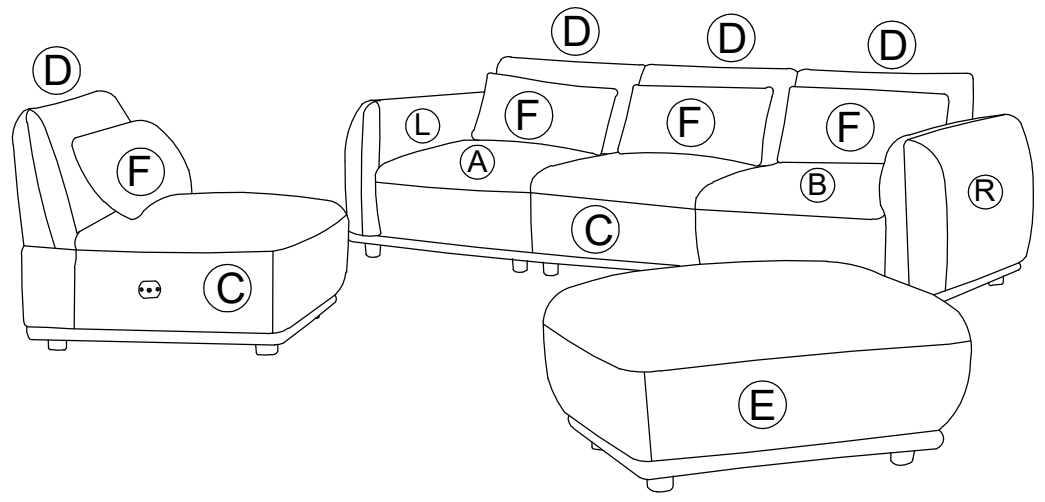
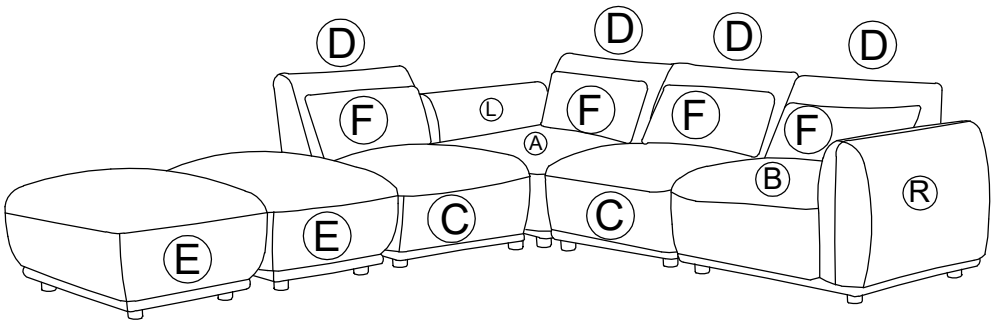
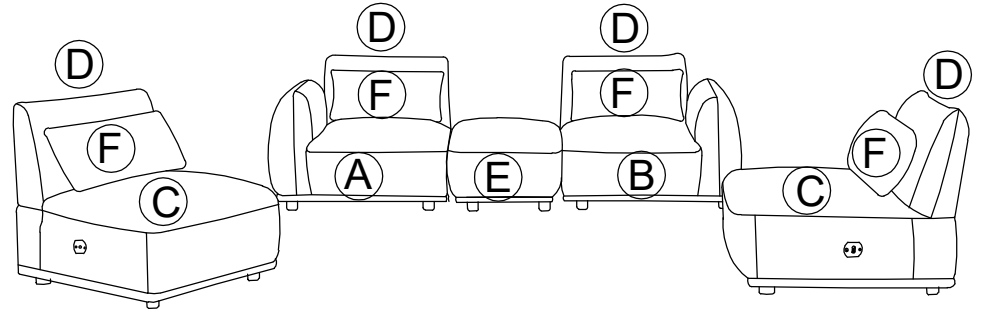
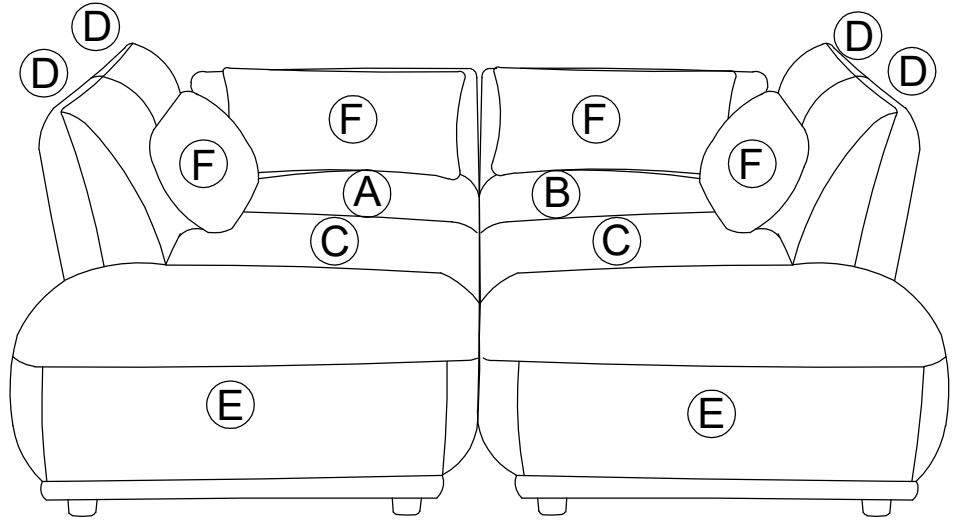

Complete

