

myRobot[®] C E N T E R

The expert for robots in your home

With one click to the online shop



myRobotcenter.eu



myRobotcenter.co.uk



myRobotcenter





YARD FORCE®

LAWN & GARDEN EQUIPMENT

LH C45W

M0E-20ET-510

GB

20V HEDGE TRIMMER

Original Instructions

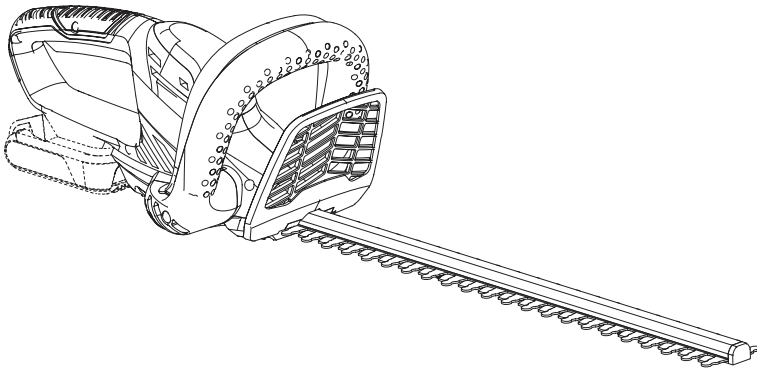

SOLD SEPARATELY



**READ & UNDERSTAND
INSTRUCTION MANUAL**

Save all warnings and instructions for future reference.

YARD FORCE

LH C45W Original Instructions

CONTENT

Intended use	04
General safety warnings	04
Product safety warnings	09
Symbols	12
Technical data	15
Description of product	16
Operation	17
Maintenance and storage	19
Troubleshooting	20
CE declaration	21



INTENDED USE

This cordless hedge trimmer is designed for cutting and trimming of hedges, bushes and ornamental shrub in the domestic environment. For safety reasons it is essential to read the entire instruction manual before first operation and to observe all the instructions.

This product is intended for private domestic use only, not for any commercial trade use. It must not be used for any purposes other than those described.

GENERAL SAFETY WARNINGS



WARNING!

Read all safety warnings and all instructions. Failure to follow the warnings and instructions may result in electric shock, fire and/or serious injury.

Save all warnings and instructions for future reference.

The term “power tool” in the warnings refers to your mains-operated (corded) power tool or battery-operated (cordless) power tool.

Work area safety

1. Keep work area clean and well lit. Cluttered or dark areas invite accidents.
2. Do not operate power tools in explosive atmospheres, such as in the presence of flammable liquids, gases or dust. Power tools create sparks which may ignite the dust or fumes.
3. Keep children and bystanders away while operating a power tool. Distractions can cause you to lose control.

GENERAL SAFETY WARNINGS

Electrical safety

1. Power tool plugs must match the outlet. Never modify the plug in any way. Do not use any adapter plugs with earthed (grounded) power tools. Unmodified plugs and matching outlets will reduce risk of electric shock.
2. Avoid body contact with earthed or grounded surfaces, such as pipes, radiators, ranges and refrigerators. There is an increased risk of electric shock if your body is earthed or grounded.
3. Do not expose power tools to rain or wet conditions. Water entering a power tool will increase the risk of electric shock.
4. Do not abuse the cord. Never use the cord for carrying, pulling or unplugging the power tool. Keep cord away from heat, oil, sharp edges or moving parts. Damaged or entangled cords increase the risk of electric shock.
5. When operating a power tool outdoors, use an extension cord suitable for outdoor use. Use of a cord suitable for outdoor use reduces the risk of electric shock.
6. If operating a power tool in a damp location is unavoidable, use a residual current device (RCD) protected supply. Use of an RCD reduces the risk of electric shock.

NOTE: The term “residual current device(RCD)” may be replaced by the term “ground fault circuit interrupter (GFCI)” or “earth leakage circuit breaker(ELCB)”

GENERAL SAFETY WARNINGS

Personal safety

1. Stay alert, watch what you are doing and use common sense when operating a power tool. Do not use a power tool while you are tired or under the influence of drugs, alcohol or medication. A moment of inattention while operating power tools may result in serious personal injury.
2. Use personal protective equipment. Always wear eye protection. Protective equipment such as dust mask, non-skid safety shoes, hard hat, or hearing protection used for appropriate conditions will reduce personal injuries.
3. Prevent unintentional starting. Ensure the switch is in the off-position before connecting to power source and/or battery pack, picking up or carrying the tool. Carrying power tools with your finger on the switch or energising power tools that have the switch on invites accidents.
4. Remove any adjusting key or wrench before turning the power tool on. A wrench or a key left attached to a rotating part of the power tool may result in personal injury.
5. Do not overreach. Keep proper footing and balance at all times. This enables better control of the power tool in unexpected situations
6. Dress properly. Do not wear loose clothing or jewellery. Keep your hair, clothing and gloves away from moving parts. Loose clothes, jewellery or long hair can be caught in moving parts.

GENERAL SAFETY WARNINGS

7. If devices are provided for the connection of dust extraction and collection facilities, ensure these are connected and properly used. Use of dust collection can reduce dust-related hazards.

Power tool use and care

1. Do not force the power tool. Use the correct power tool for your application. The correct power tool will do the job better and safer at the rate for which it was designed.
2. Do not use the power tool if the switch does not turn it on and off. Any power tool that cannot be controlled with the switch is dangerous and must be repaired.
3. Disconnect the plug from the power source and/or the battery pack from the power tool before making any adjustments, changing accessories, or storing power tools. Such preventive safety measures reduce the risk of starting the power tool accidentally.
4. Store idle power tools out of the reach of children and do not allow persons unfamiliar with the power tool or these instructions to operate the power tool. Power tools are dangerous in the hands of untrained users.
5. Maintain power tools. Check for misalignment or binding of moving parts, breakage of parts and any other condition that may affect the power tool's operation. If damaged, have the power tool repaired before use. Many accidents are caused by poorly maintained power tools.

GENERAL SAFETY WARNINGS

6. Keep cutting tools sharp and clean. Properly maintained cutting tools with sharp cutting edges are less likely to bind and are easier to control.
7. Use the power tool, accessories and tool bits etc. in accordance with these instructions, taking into account the working conditions and the work to be performed. Use of the power tool for operations different from those intended could result in a hazardous situation.

Battery tool use and care

1. Recharge only with the charger specified by the manufacturer. A charger that is suitable for one type of battery pack may create a risk of fire when used with another battery pack.
2. Use power tools only with specifically designated battery packs. Use of any other battery packs may create a risk of injury and fire.
3. When battery pack is not in use, keep it away from other metal objects, like paper clips, coins, keys, nails, screws or other small metal objects that can make a connection from one terminal to another. Shorting the battery terminals together may cause burns or a fire.
4. Under abusive conditions, liquid may be ejected from the battery; avoid contact. If contact accidentally occurs, flush with water. If liquid contact eyes, additionally seek medical help. Liquid ejected from the battery may cause irritation or burns.

PRODUCT SAFETY WARNINGS

Service

Have your power tool serviced by a qualified repair person using only identical replacement parts. This will ensure that the safety of the power tool is maintained.

SPECIAL SAFETY INSTRUCTIONS FOR CORDLESS HEDGE TRIMMER

1. Keep all parts of the body away from the cutter blade. Do not remove cut material or hold material to be cut when blades are moving. Make sure the switch is off when clearing jammed material. A moment of inattention while operating the hedge trimmer may result in serious personal injury.
2. Carry the hedge trimmer by the handle with the cutter blade stopped. When transporting or storing the hedge trimmer always fit the cutting device cover. Proper handling of the hedge trimmer will reduce possible personal injury from the cutter blades.
3. Hold the power tool by insulated gripping surfaces only, because the cutter blade may contact hidden wiring. Cutter blades contacting a “live” wire may make exposed metal parts of the power tool “live” and could give the operator an electric shock.
4. Keep cable away from cutting area. During operation the cable may be hidden in shrubs and can be accidentally cut by the blade.
5. Check the hedge for foreign objects before operating, e.g. wire fences.
6. Only use the hedge trimmer with the guard properly

PRODUCT SAFETY WARNINGS

- assembled. The use of the hedge trimmer without the proper guard may result in serious personal injury!
7. Use both hands when operating the hedge trimmer. Using one hand could cause loss of control and result in serious personal injury.
 8. Do not grasp the exposed cutting blades or cutting edges when picking up or holding the hedge trimmer.
 9. Do not use on a ladder, rooftop, tree, or other unstable support. Stable footing on a solid surface enables better control of the hedge trimmer in unexpected situations.
 10. Never allow children to operate the hedge trimmer.
 11. Never remove or tamper with safety devices. Check their proper operation regularly. Never do anything to interfere with the intended function of a safety device or to reduce the protection provided by a safety device.
 12. Never operate the hedge trimmer without proper guards, plates, or other safety protective devices in place.
 13. Check damaged parts before further use of the hedge trimmer. A guard or other part that is damaged should be carefully checked to determine that it will operate properly and perform its intended function. Check for alignment of moving parts, binding of moving parts, breakage of parts, mounting, and any other condition that may affect its operation. A guard or other part that is damaged should be properly repaired or replaced by an authorized service center unless indicated elsewhere in this manual.

PRODUCT SAFETY WARNINGS

14. Check the blade and motor mounting bolts at frequent intervals for proper tightness. Also, visually inspect blade for damage (e.g., bent, cracked, and worn).
15. Replace the blade if it is bent or cracked. An unbalanced blade causes vibration that could damage the motor drive unit or cause personal injury.
16. If the equipment should start to vibrate abnormally, stop the motor and check immediately for the cause. Vibration is generally a warning of trouble.
17. The trimmer shall be used to cut stems less than (16 mm) thick.
18. Trim only in daylight or in good artificial light.
19. Remove or disconnect battery before servicing, cleaning, or removing material from the hedge trimmer.
20. Do not wash with a hose; avoid getting water in motor and electrical connections.
21. When servicing use only identical replacement parts listed in this manual. Use of parts which do not meet the original equipment specifications may lead to improper performance and compromised safety.
22. Follow instructions for lubricating and changing accessories.
23. Keep handles dry, clean and free from oil and grease.
24. Save these instructions. Refer to them frequently and use them to instruct others who may use this tool. If you loan this tool to someone else, also loan these instructions to them to prevent misuse of the product and possible injury.

SYMBOLS

Safety symbols

The purpose of safety symbols is to attract your attention to possible dangers. The safety symbols and the explanations with them require your careful attention and full understanding. The symbol warnings do not, by themselves, eliminate any danger. The instructions and warnings they give are no substitutes for proper accident prevention measures.

WARNING: Be sure to read and understand all safety instructions in this operator's manual, including all safety alert symbols such as "**DANGER**," "**WARNING**," and "**CAUTION**" before using this tool. Failure to follow all instructions listed below may result in electric shock, fire and/or serious personal injury.

SAFETY ALERT SYMBOL: Indicates **DANGER**, **WARNING**, or **CAUTION**. May be used in conjunction with other symbols or pictographs.

Symbol meaning

This page depicts and describes safety symbols that may appear on this product. Read, understand and follow all instructions on the machine before attempting to assemble and operate.

SYMBOLS



Please read all of the safety and operating instructions carefully before using this machine. Read the instruction manual before operating.



WARNING! Failure to follow the warnings and instructions may result in electric shock, fire and/or serious injury.



Do not use this tool in the rain. Avoid using it in damp conditions.



Wear ear protection.



Wear eye protection.



Wear a dust mask.



The product complies with the applicable European directives, and an evaluation method of conformity for these directives was done.

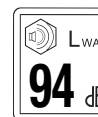

Sound level data (94 dB), in accordance with Directive 2000/14/EC.



Keep bystanders away. Objects thrown by the product could hit the user or other bystanders. Always ensure that other people and pets remain at a safe distance from the product when it is in operation.

SYMBOLS



Danger-Keep hands away from blades. Contact with blade will result in serious personal injury.



Disconnect the battery pack before any repair or maintenance.

TECHNICAL DATA

Model		LH C45W
Voltage		20 V
No load speed		1300 rpm
Max. cutting capacity		16 mm
Blade length		510 mm
Measured sound pressure level(L _{pA})		79 dB(A) K=3.0 dB(A)
Measured sound power level(L _{WA})		90 dB(A) K=3.0 dB(A)
Guaranteed sound power level(L _{WA})		94 dB(A)
Net weight		2.3 kg
Vibrations		2 m/s ² K=1.5 m/s ²

The sound values have been determined according to noise test code given in EN 60745-2-15, using the basic standards EN ISO 11094 and EN ISO 3744. The noise figures quoted are emission levels and are not necessarily safe working levels.

Factors that influence the actual level of exposure of work-force include the characteristics of the work room, the other sources of noise, etc. i.e. the number of machines and other adjacent processes, and the length of time for which an operator is exposed to the noise. Also the permissible exposure level can vary from country. This information, however, will enable the user of the machine to make a better evaluation of the hazard and risk. Wear hearing protection! The sound intensity level for the operator may exceed 80 dB (A) and ear protection measures are necessary!

The declared vibration value has been measured in accordance with a standard test method (according to EN 60745-2-15) and may be used for comparing one product with another. The declared vibration value may also be used in a preliminary assessment of exposure. This tool may cause hand-arm vibration syndrome if its use is not adequately managed.

DESCRIPTION OF PRODUCT

Parts description

1. Blade
2. Safety button
3. ON/OFF trigger
4. Battery pack slot

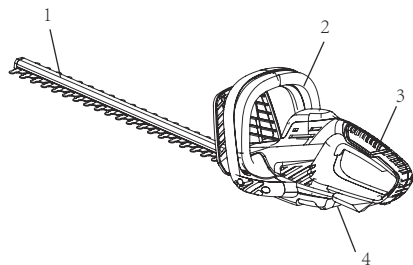

Delivery contents

Carefully unpack the appliance and check that it is complete. Dispose of the packaging material correctly.

- a. Blade shield
- b. Hedge trimmer
- c. Instruction manual

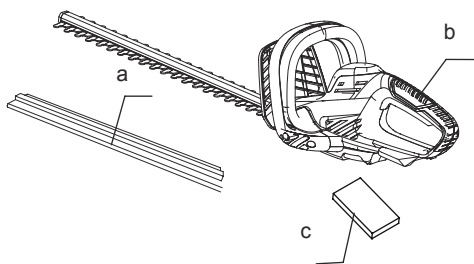

WARNING: If any parts are damaged or missing, do not operate this tool until these parts are replaced. Failure to heed this warning could result in serious personal injury.



NOTE: Always recycle the packaging in accordance with local recycling guidelines.

OPERATION

Demount the blade shield

To insert the battery pack

1. Align the groove on the battery pack with the corresponding ribs in the receptacle of the device.
2. Insert the battery pack with moderate force until it locks in to place.

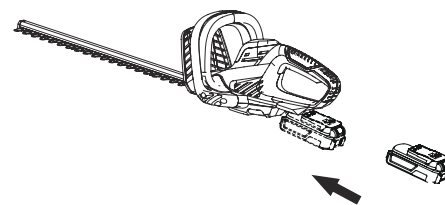

To remove the battery pack from the tool

1. Press the battery pack release button.
2. Remove the battery pack from the tool.

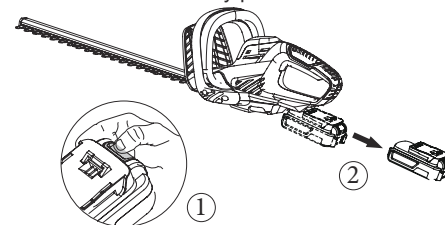

Starting/Stopping the Hedge Trimmer

Before operating, remove the blade guard and hold the trimmer with both hands, one hand on the rear handle and the other on the front handle. Then check for balanced footing, upright standing and a proper cutting distance.

To Start

Depress and hold the front switch lever and continue pressing the rear switch lever to start.

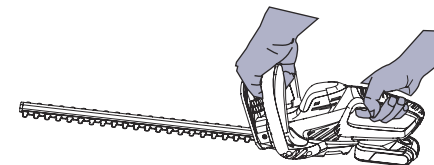

To Stop

Release either of the switch levers to stop it.

NOTICE: Both switch levers need to be pressed for the hedge trimmer to start.

OPERATION

Cutting Tips

WARNING: To prevent serious personal injury, keep hands away from blades. Do not attempt to remove cut material or hold material to be cut when the blades are moving. Make sure that the blades have totally stopped and the battery pack is removed before clearing jammed material from blades. Do not grasp the exposed cutting blades or cutting edges when picking up or holding the unit.

WARNING: Clear the area to be cut before each use. Remove all objects, such as cords, lights, wire, or string which can become entangled in the cutting blade and create a risk of serious personal injury.

WARNING: Avoid trimming too much at one time or through the heavy shrubbery. This can cause the blades to bind and slow, reducing the cutting efficiency.

Top Cutting

Use a wide sweeping motion. A slight downward tilt of the cutting blades in the direction of motion gives the best cutting results. For better cutting effect, you might as well use the string to guide the hedge level.

Side Cutting

When trimming the sides of the hedge, begin at the bottom and cut upwards.

MAINTENANCE AND STORAGE

WARNING: When servicing, use only identical replacement parts. Use of any other parts may create a hazard or cause product damage. To ensure safety and reliability, all repairs should be performed by a qualified service technician.

WARNING: To avoid serious personal injury, always remove the battery pack from the product when cleaning or performing any maintenance.

Cleaning

1. Use a soft brush to remove debris from all air intakes and cutting blade.
2. To remove pitch and other sticky residue, spray the blades with resin solvent. Run the motor briefly so that the solvent is evenly distributed.
3. Wipe the surface with a dry cloth.

Maintenance

1. Keep all nuts, bolts and screws tight to be sure that the machine is in safe working condition.
2. Examine the machine and replace worn or damaged parts for safety.
3. Check that the guards are undamaged and correctly fitted. Carry out necessary maintenance or repairs before using.
4. Do not use the unit if the blades are blunt or worn. This will overstress the motor and gearbox of the machine.

Lubricating the blade

For best operation and longer blade life, lubricate the hedge trimmer blade with light weight machine oil before and after each use. Remove the battery pack and lay the trimmer onto a flat surface. Apply the oil along the edge of the top blade.

Transporting and storing

1. Always place the blade guard on the blade before storing or transporting the hedge trimmer. Use caution to avoid the sharp teeth of the blade.
2. Clean the hedge trimmer thoroughly before storing.
3. Store the hedge trimmer indoors, in a dry place that is inaccessible to children.
4. Keep away from corrosive agents such as garden chemicals and deicing salts.

TROUBLESHOOTING

WARNING!

Before performing any repair work, always remove the battery pack.

Caution!

Improper repairs can result in the product functioning unsafely. This endangers yourself and your environment.

Faults which cannot be rectified with the aid of following table may be rectified by a specialist company only (customer service center).

Please be aware that any improper repairs will also invalidate the warranty and additional costs may be incurred.

Use only genuine spare parts. Only these spare parts are designed and suitable for the product. The use of other spare parts not only voids the warranty, you can also endanger yourself and your environment.

Fault	Possible cause	Solution
Product is not running.	No electrical contact between the trimmer and battery	Remove battery, check contacts and reinstall the battery pack
	The battery pack is depleted	Charge the battery pack
	The two switch levers are not depressed simultaneously	Depress the switch levers on the front and rear handle simultaneously
	The battery pack is too hot	Remove the battery pack from the tool and allow it to cool until the temperature drops below 50°C

CE DECLARATION

To the provisions of Council Directives

We
MEROTEC GmbH,
Otto-Brenner-Straße 8,
47877 Willich/ Deutschland

Declare that the product:
Description: 20V HEDGE TRIMMER
Model No. LH C45W/ MOE-20ET-510
Function: Trimming of hedges bushes

Complies with the essential health and safety requirements of the following directives:

Machinery Directive 2006/42/EC
Electromagnetic Compatibility Directive 2014/30/EU
EC Directive 2011/65/EU and its amendment Directive (EU) 2015/863 (RoHS)
Noise Directive, amended by 2005/88/EC conformity assessment procedure:
2000/14/EC Annex VI
Measured Sound Power Level: 90 dB (A) K=3.0dB(A)
Declared Guaranteed Sound Power Level: 94 dB (A)

Standards and technical specification referred to:

EN 60745-1:2009+A11:2010
EN 60745-2-15:2009+A11:2010
EN 55014-1:2017
EN 55014-2:2015

Authorized Signatory
Date: 24.03.2020

Signature: 
Place: Willich
Name: Roland Menken
General Manager

MEROTEC GmbH,
Otto-Brenner-Straße 8,
47877 Willich/ Deutschland



*) The object of the declaration described above satisfies the provisions of directive 2011/65/EU of the European Parliament and the Council of 8 June 2011 on limiting the use of certain harmful substances in electrical and electronic appliances.