

# MS-80IR+

## MULTISTOMP

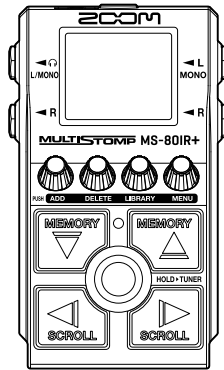

## Quick Tour

Software and documents related to this product can be viewed on the following website.



[zoomcorp.com/help/ms-80irplus](https://zoomcorp.com/help/ms-80irplus)

**You must read the Usage and Safety Precautions before use.**

© 2024 ZOOM CORPORATION

Copying or reprinting this manual in part or in whole without permission is prohibited.

You might need this manual in the future. Always keep it in a place where you can access it easily.

The contents of this manual and the specifications of the product could be changed without notice.

Proper display is not possible on grayscale devices.

# Installing batteries

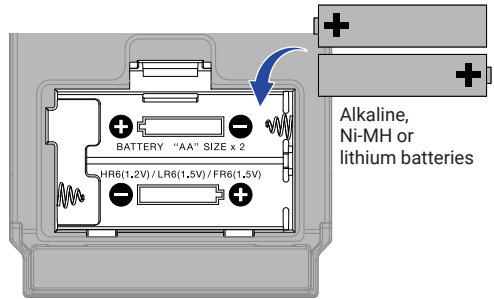
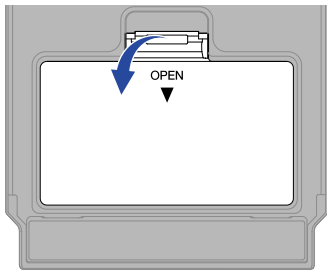

When using batteries, follow these precautions to prevent leakage.

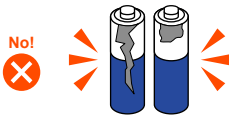

Do not use batteries if their covers are coming off or their exteriors are damaged.

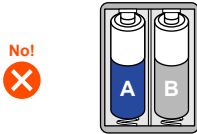

Do not mix batteries of different types or made by different manufacturers.



Do not use new and old batteries together.

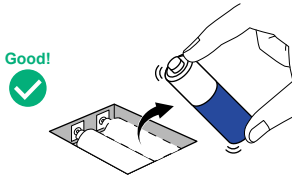

Remove dead batteries as soon as possible.  
Remove batteries when not using them for a long time.



## Turning effects on/off

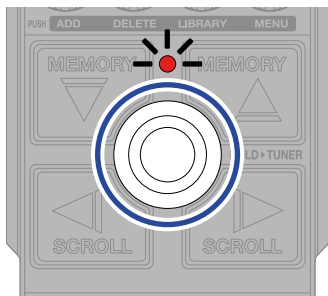

## Adjusting effects

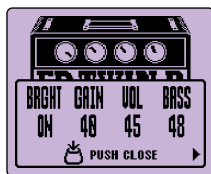
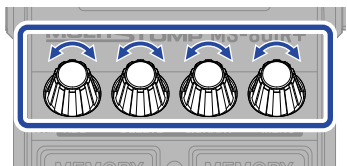

Press  to close the parameter screen.

When parameters are on multiple pages, ► / ◀ will be shown.

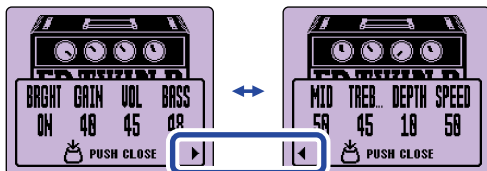
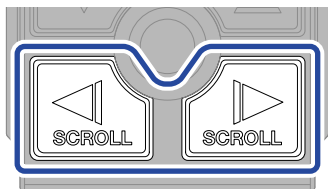

# Replacing effects

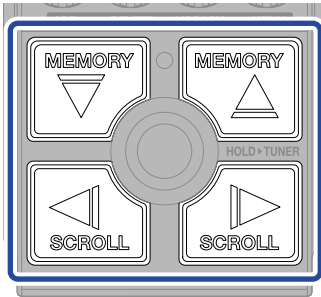
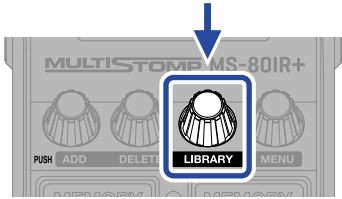

Select



LIBRARY Screen

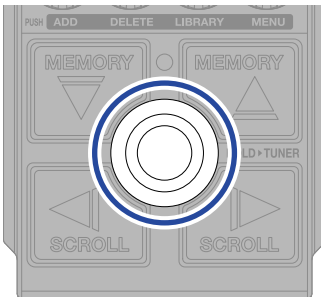

Confirm

# Adding effects

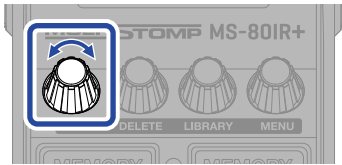
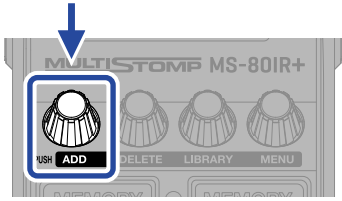

Select

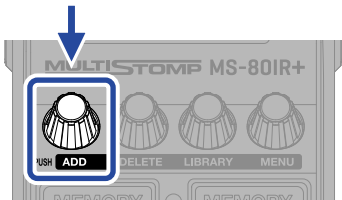

Confirm

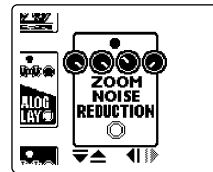

Select an effect from the library and create an original sound.

One amp model, one studio ambience and one other effect can be combined freely on the MS-80IR+. The following message will appear when trying to add an effect that would exceed the maximum combination limit. Delete one effect before adding another one.



## Changing the effect position shown

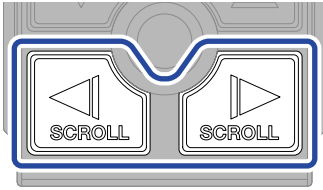

## Deleting effects

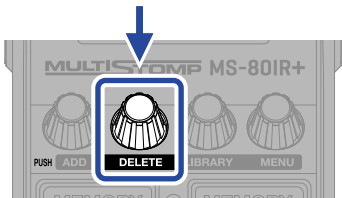

Select

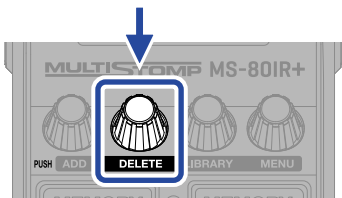
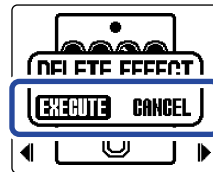

Execute



# Switching patch memories

Patch memories store effect on/off states and parameter setting values. MS-80IR+ effects are saved and recalled in units of patch memories. Up to 3 effects can be used in a single patch memory.

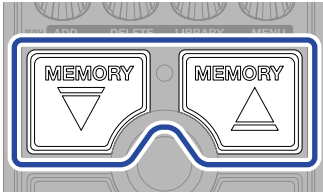
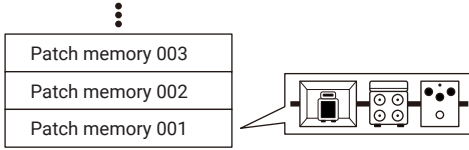

Use these to switch patch memories, enabling performance with various tones.



# Using the tuner

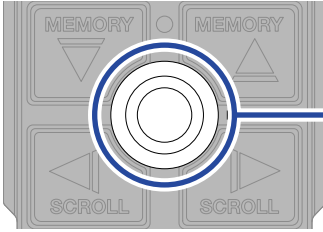

Press and hold

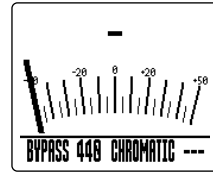

TUNER Screen

- Play an open string and adjust its pitch to tune it.
- The nearest note name and pitch detuning will be shown.

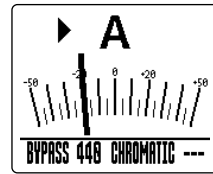

- ▶◀ will appear when the pitch is in tune.

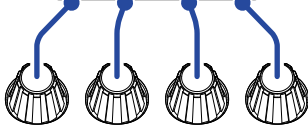
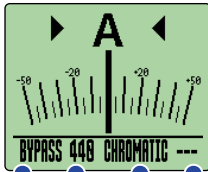
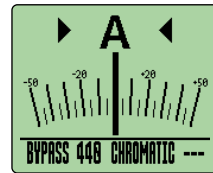

Use  to change tuner settings.

Output sound	BYPASS / MUTE
Standard pitch	430 Hz – 450 Hz
Tuner type	The desired tuner type can be selected.
Flat tuning	All strings can be tuned flat from an ordinary tuning by 1 (♭ 1), 2 (♭ 2) or 3 (♭ 3) semitones.

# Using the MENU

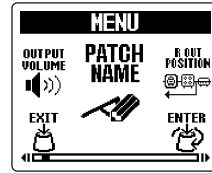
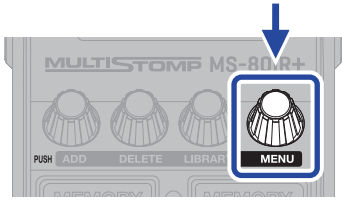

MENU Screen

<p><b>OUTPUT VOLUME</b></p>	Adjust the overall volume.	<p><b>PATCH NAME</b></p>	Change the patch memory name.
<p><b>R OUT POSITION</b></p>	Change the position in the patch memory from which the R channel signal is output.	<p><b>MOVE EFFECT</b></p>	Change the effect order.
<p><b>BPM</b></p>	The BPM, which is used for the tempo synchronization of delay time, for example, can be set separately for each patch memory.	<p><b>REVERT PATCH</b></p>	This restores a changed patch memory to the state it was in immediately after selection or to its factory default settings.
<p><b>COPY PATCH</b></p>	Copy a patch memory and save it in a different location.	<p><b>NEW PATCH</b></p>	Create a new patch memory.
<p><b>ERASE PATCH</b></p>	Delete a patch memory.	<p><b>AUTO SAVE</b></p>	Turn the automatic saving function on/off.
<p><b>PRE-SELECT</b></p>	Turn the preselect function on/off.	<p><b>LIBRARY SOUND</b></p>	The output sound on the LIBRARY Screen (when changing effects) can be set to either just the selected effect or the entire patch memory.
<p><b>BATTERY TYPE</b></p>	Set the type of batteries.	<p><b>BACKLIGHT</b></p>	Set the backlight brightness.
<p><b>CONTRAST</b></p>	Adjust the display contrast.	<p><b>ECO MODE</b></p>	Turn the ECO mode on/off.
<p><b>USB MONITOR</b></p>	Adjust the monitoring balance for USB AUDIO.	<p><b>USB REC GAIN</b></p>	Adjust the volume (recording level) sent to the computer, smartphone or tablet using USB AUDIO.

<p><b>USB MIDI CH</b></p> 	<p>Set the channel used to receive USB MIDI.</p>	<p><b>FACTORY RESET</b></p> 	<p>Restore the factory default settings.</p>
<p><b>VERSION</b></p> 	<p>Check firmware versions.</p>	<p><b>HELP</b></p> 	<p>Use a smartphone to scan a 2D code and access detailed documents related to the product.</p>

See the Operation Manual for detailed information about all the functions.

# Functions of parts

## ■ Top

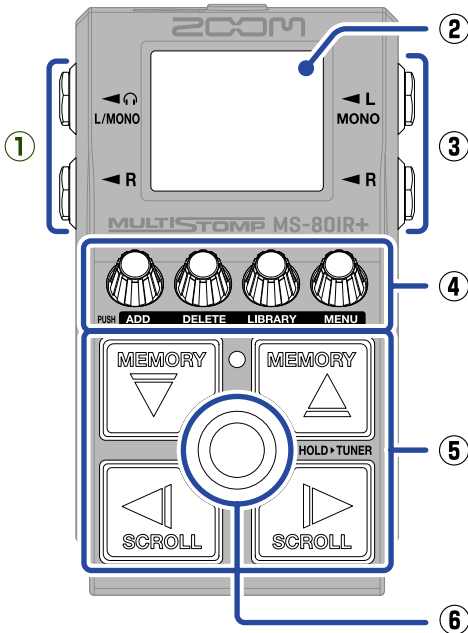

### ① Output jacks

Connect powered monitors or headphones here.

### ② Display

This shows the selected patch memory and its effects, along with their parameter setting values, and other information.

### ③ Input jack

Connect a guitar here.

### ④ Parameter knobs

Use these to adjust effect parameters and make various settings.

### ⑤ Direction buttons

Use these to select patch memories and effects, for example. They can be operated by foot.

### ⑥ Footswitch

This turns the effect on/off. Press and hold this to switch to the tuner.

## ■ Bottom

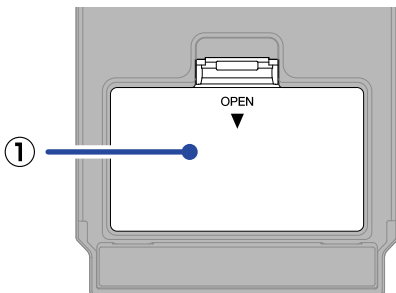

### ① Battery cover

Open this when installing or removing AA batteries.

## ■ Back

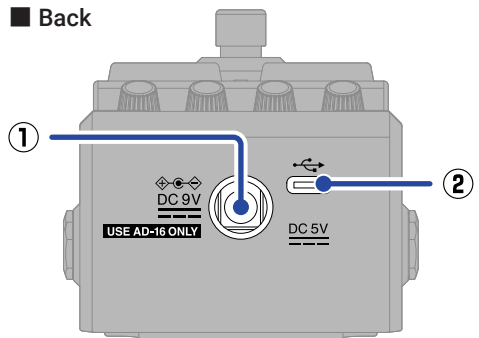

### ① DC 9V AC adapter connector

Connect the dedicated AC adapter (ZOOM AD-16) here.

### ② USB (Type-C) port

Connect this to a computer, iPhone or iPad. This supports operation on USB bus power.

## Other functions

### ■ Effective use of the R OUT POSITION

When using the MS-80IR+ on stage performing live, for example, suitable sounds can be output separately for a PA system and for a guitar amp.

For the PA system, sound processed by a cabinet simulation and another effect can be output from the L output jack. For the guitar amp, sound processed only by an amp head model can be output from the R output jack.

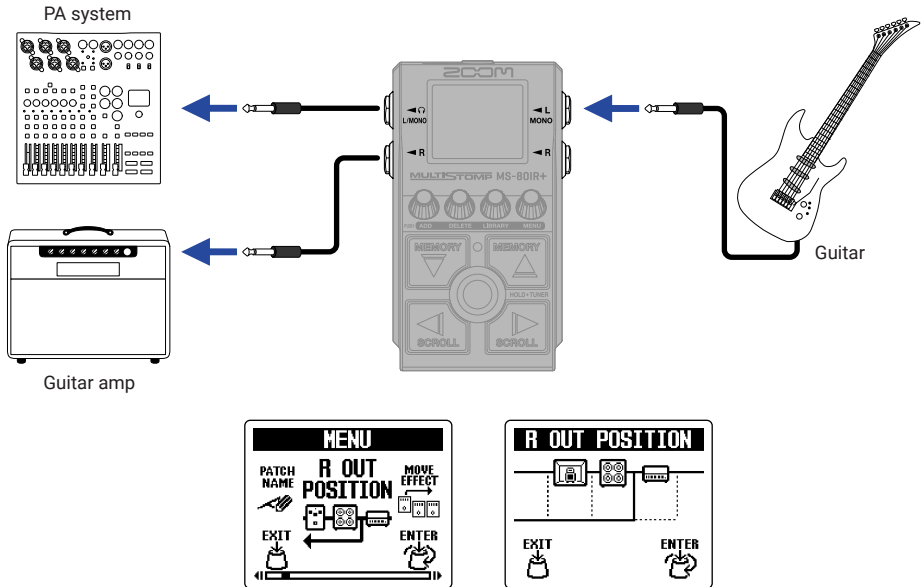

## ■ Audio interface

Connected to a computer, smartphone or tablet, this can be used as a 2-in/2-out audio interface.

In addition to recording with your DAW software, you can enjoy performing while mixing sound played from a smartphone with the MS-80IR+ sound.

A driver must be installed to connect with Windows computers. The latest driver can be downloaded from the ZOOM website ([zoomcorp.com/help/ms-80irplus](http://zoomcorp.com/help/ms-80irplus)).

- Example of connection when recording with DAW software

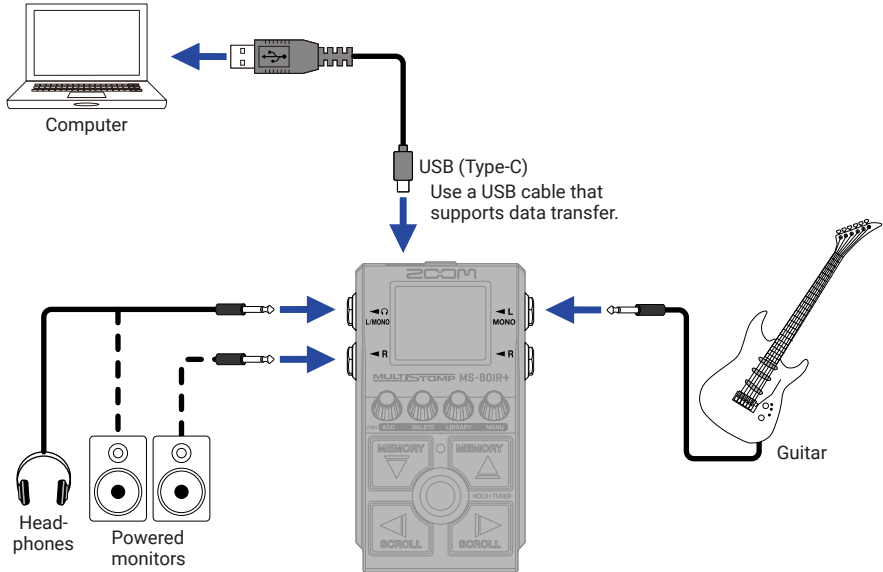

- Example of connection when performing while mixing sound played from a smartphone

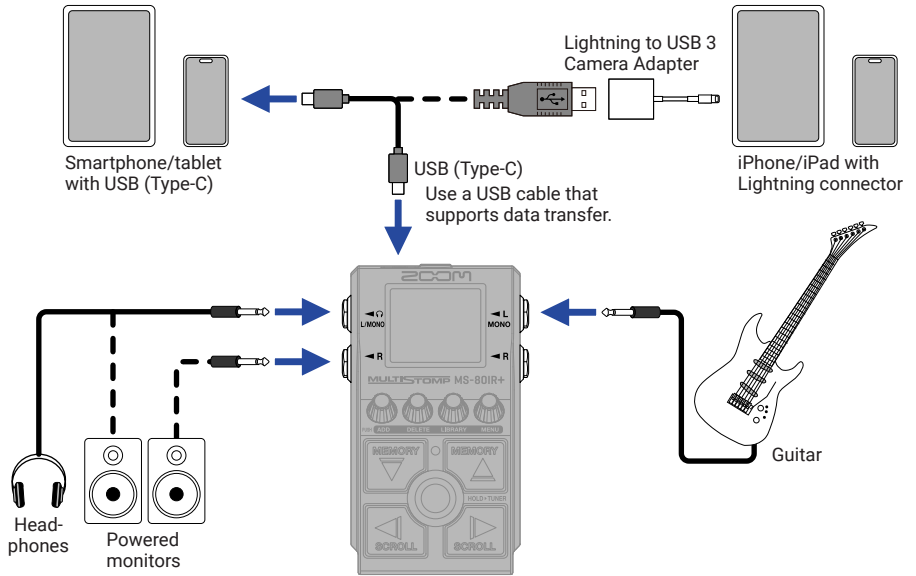

## ■ Handy Guitar Lab for MS-80IR+

With this dedicated app, iPhones and iPads can be used to manage patch memories, load impulse response data and edit effects.

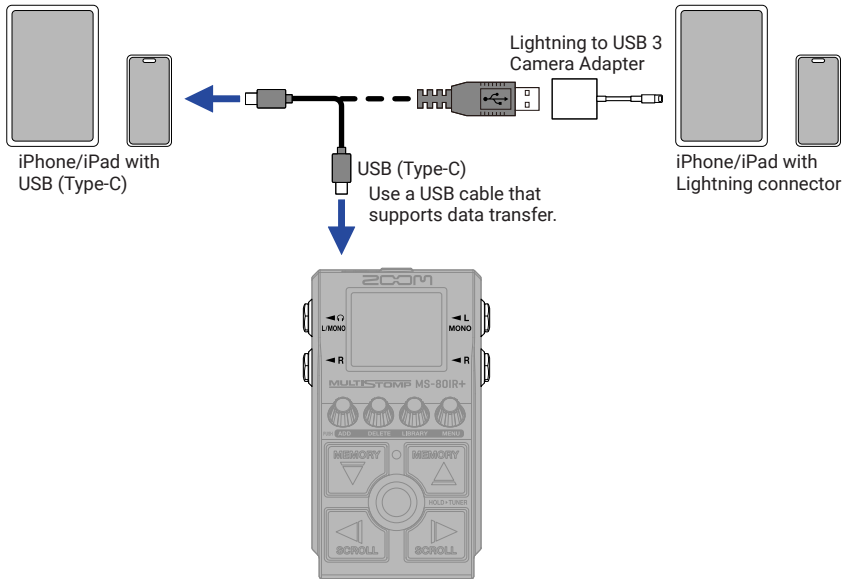

# Troubleshooting

## The unit will not power on

- Check the connections.
- If using batteries, connect a cable to the INPUT (L/MONO) jack.
- If the ON/OFF indicator blinks and it will not start, update the firmware.

## There is no sound or output is very quiet

- Check the connections.
- Adjust the levels of the effects.
- Adjust the output volume.
- Confirm that the tuner output setting is not "MUTE".

## Sound from the R output jack is strange

- Check the R OUT POSITION setting.

## There is a lot of noise

- Confirm that nothing is wrong with the instrument cable.
- Use a genuine AC adapter (ZOOM AD-16).

## An effect cannot be selected

- "MAX EFFECTS. DELETE ONE." will appear on the display when trying to add an effect that would exceed the maximum combination limit. Delete one effect before adding another one.

Product names, registered trademarks and company names in this document are the property of their respective companies.

Microsoft and Windows are trademarks of the Microsoft group of companies.

iPad, iPhone and Lightning are trademarks of Apple Inc.

USB Type-C is a trademark of the USB Implementers Forum.

All trademarks and registered trademarks in this document are for identification purposes only and are not intended to infringe on the copyrights of their respective owners.

The illustrations and display screens in this document could differ from the actual product.

The ZOOM logo is rendered in a bold, black, stylized font. The letters are thick and blocky, with a distinctive design where the 'O's are connected to the 'M'. A registered trademark symbol (®) is located to the right of the 'M'.

**ZOOM CORPORATION**

4-4-3 Kanda-surugadai, Chiyoda-ku, Tokyo 101-0062 Japan

zoomcorp.com